

# Smartgen®

## HGM9580 Bus Tie Bus Parallel Unit

### USER MANUAL



Smartgen Technology



众智电子 Chinese trademark

**Smartgen**<sup>®</sup> English trademark

**Smartgen** — make your generator *smart*

Smartgen Technology Co., Ltd.

No. 28 Jinsuo Road

Zhengzhou city

Henan Province

P. R. China

Tel: +86-371-67988888/67981888

+86-371-67991553/67992951

+86-371-67981000(overseas)

Fax: 0086-371-67992952

Web: <http://www.smartgen.com.cn>

<http://www.smartgen.cn>

Email: [sales@smartgen.cn](mailto:sales@smartgen.cn)

All rights reserved. No part of this publication may be reproduced in any material form (including photocopying or storing in any medium by electronic means or other) without the written permission of the copyright holder.



Smartgen Technology reserves the right to change the contents of this document without prior notice.

#### Version history

Date	Version	Contents
2014-02-16	1.0	Original release

This manual is suitable for HGM9580 bus tie bus parallel unit only.

Clarification of notation used within this publication.

SIGN	INSTRUCTION
 NOTE	Highlights an essential element of a procedure to ensure correctness.
 CAUTION!	Indicates a procedure or practice, which, if not strictly observed, could result in damage or destruction of equipment.
 WARNING!	Indicates a procedure or practice, which could result in injury to personnel or loss of life if not followed correctly.

SmartGen

# CONTENTS

<b>1 OVERVIEW .....</b>	<b>5</b>
<b>2 PERFORMANCE AND CHARACTERISTICS .....</b>	<b>6</b>
<b>3 SPECIFICATION.....</b>	<b>7</b>
<b>4 OPERATION .....</b>	<b>8</b>
4.1 INDICATOR LIGHT .....	8
4.2 PUSHBUTTONS .....	9
4.3 LCD DISPLAY .....	10
4.3.1 MAIN DISPLAY.....	10
4.3.2 USER MENU AND PARAMETERS SETTING MENU .....	10
4.4 AUTO OPERATION.....	13
4.5 MANUAL OPERATION.....	14
<b>5 PROTECTIONS.....</b>	<b>15</b>
5.1 WARNING ALARMS.....	15
5.2 TRIP ALARM .....	16
<b>6 WIRING CONNECTION .....</b>	<b>17</b>
<b>7 SCOPES AND DEFINITIONS OF PROGRAMMABLE PARAMETERS .....</b>	<b>20</b>
7.1 CONTENTS AND SCOPES OF PARAMETERS.....	20
7.2 ENABLE DEFINITION OF PROGRAMMABLE OUTPUT PORTS.....	24
7.2.1 DEFINED COMBINATION OUTPUT .....	26
7.3 DEFINED CONTENTS OF PROGRAMMABLE INPUT PORTS (ALL ACTIVE WHEN CONNECT TO GRAND (B~)).....	27
<b>8 TYPICAL DIAGRAM .....</b>	<b>29</b>
<b>9 TYPICAL APPLICATION .....</b>	<b>30</b>
<b>10 INSTALLATION .....</b>	<b>31</b>
<b>11 USB.....</b>	<b>32</b>
<b>12 FAULT FINDING .....</b>	<b>33</b>

## 1 OVERVIEW

**HGM9580** Bus Tie Bus Parallel Unit is designed for manual/auto parallel system which composed by multi-way bus and multi-way bus. It allows automatic parallel running function. It fit with LCD display, graphic display, optional Chinese, English and other languages interface, and it is reliable and easy to use.

**HGM9580** Bus Tie Bus Parallel Unit controls a bus breaker which can control the controller to synchronize the two ways buses via MSC CAN if the synchronization requirements have satisfied. The powerful 32-bit Microprocessor contained within the unit allows for precision parameters measuring, fixed value adjustment, time setting and set value adjusting and etc..Majority parameters can be configured from front panel, and all parameters can be configured by USB interface (or RS485) to adjust via PC. It can be widely used in all types of automatic genset parallel system with compact structure, simple connections and high reliability.

SmartGen

## 2 PERFORMANCE AND CHARACTERISTICS

- With ARM-based 32-bit SCM, high integration of hardware and more reliable;
- 480x272 TFT LCD with backlight, multilingual interface (including English, Chinese or other languages) which can be chosen at the site, making commissioning convenient for factory personnel;
- Improved LCD wear-resistance and scratch resistance due to hard screen acrylic;
- Silicon panel and pushbuttons for better operation in high/low temperature environment;
- RS485 communication port enables remote control, remote measuring, remote communication via ModBus protocol.
- Suitable for 3-phase 4-wire, 3-phase 3-wire, single phase 2-wire, and 2-phase 3-wire systems with voltage 120/240V and frequency 50/60Hz;
- Collects and shows 3-phase voltage and frequency of Bus 1/Bus 2.

### Bus 1

Line voltage (Uab, Ubc, and Uca)

Phase voltage (Ua, Ub, and Uc)

Phase sequence

Frequency (Hz)

### Bus 2

Line voltage (Uab, Ubc, and Uca)

Phase voltage (Ua, Ub, and Uc)

Phase sequence

Frequency (Hz)

- Synchronization parameters : Voltage Difference Between Bus 1 and Bus 2, Frequency Difference Between Bus 1 and Bus 2, Phase Difference Between Bus 1 and Bus 2;
- All output ports are relay output;
- Parameter setting: parameters can be modified and stored in internal EEPROM memory and cannot be lost even in case of power outage; most of them can be adjusted using front panel of the controller and all of them can be modified using PC via USB or RS485 ports;
- Widely power supply range DC(8~35)V, suitable to different starting battery voltage environment;
- Event log, real-time clock function;
- All parameters used digital adjustment, instead of conventional analog modulation with normal potentiometer, more reliability and stability;
- IP55 waterproofness level can be achieved with the help of rubber-ring gasket between shell and control panel.
- Metal fixing clips enable perfect in high temperature environment ;
- Modular design, self extinguishing ABS plastic shell, pluggable terminal, built-in mounting , compact structure with easy installation ;

### 3 SPECIFICATION

Parameter	Details
Working Voltage	DC8. 0V to 35. 0V, continuous power supply
Overall Consumption	<4W (Standby mode: ≤2W)
AC Input: 3 Phase 4 Wire 3 Phase 3 Wire Single Phase 2 Wire 2 Phase 3 Wire	AC15V - AC360V (ph-N) AC30V - AC620V (ph- ph) AC15V - AC360V (ph-N) AC15V - AC360V (ph-N)
Alternator Frequency	50Hz/60Hz
Flexible Relay Output 1	7A DC28V power supply output
Flexible Relay Output 2	7A DC28V power supply output
Flexible Relay Output 3	7A DC28V power supply output
Flexible Relay Output 4	7A AC250V volts free output
Flexible Relay Output 5	7A AC250V volts free output
Flexible Relay Output 6	7A AC250V volts free output
Flexible Relay Output 7	16A DC28V power supply output
Flexible Relay Output 8	16A DC28V power supply output
Case Dimensions	266mm x 182mm x 45mm
Panel Cutout	214mm x 160mm
Working Conditions	Temperature: (-25~+70)°C      Humidity: (20~93)%RH
Storage Conditions	Temperature:(-25~+70)°C
Protection Level	IP55 Gasket
Insulation Intensity	Apply AC2.2kV voltage between high voltage terminal and low voltage terminal; The leakage current is not more than 3mA within 1min.
Weight	0.95kg

## 4 OPERATION

### 4.1 INDICATOR LIGHT

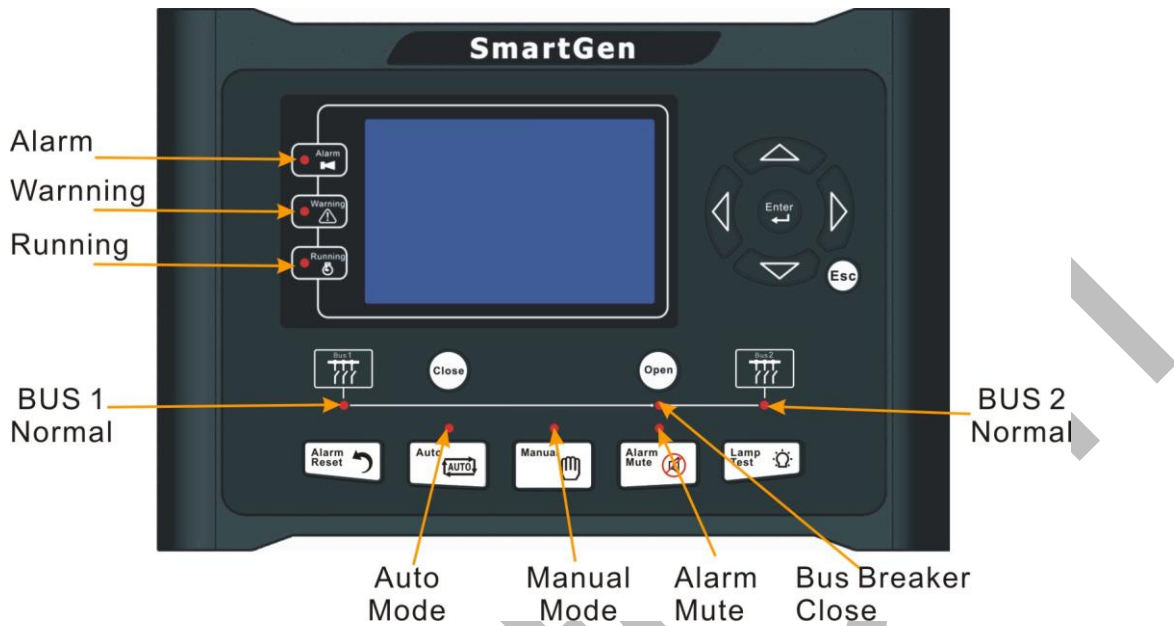

**NOTE:** Selected light indicators description:

Warning indicator and Alarm indicator:

Alarm Type	Warning Indicator	Alarm Indicator
Warning	Slow flashing	Slow flashing
Trip Alarm	Off	Fast flashing









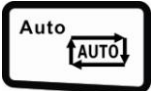

Running indicator: It is light on when both of bus 1 and bus 2 are normal; off when either of them is abnormal.

Bus 1 normal light: It is light on when bus 1 is normal; off when bus 1 is abnormal.

Bus 2 normal light: It is light on when bus 2 is normal; off when bus 2 is abnormal.







## 4.2 PUSHBUTTONS

	Alarm Reset	If alarm occurs, pressing the button can reset this alarm.
	Manual Mode	Press this key and controller enters in <b>Manual</b> mode.
	Auto Mode	Press this key and controller enters in <b>Auto</b> mode.
	Mute	Alarming sound off.
	Lamp test	Press this key can test the lamp is normal or not (lamp test).
	Close	Can control bus to switch on in <b>Manual</b> mode.
	Open	Can control bus to switch off in <b>Manual</b> mode.
	Up/Increase	1) Screen scroll; 2) Up cursor and increase value in setting menu.
	Down/Decrease	1) Screen scroll; 2) Down cursor and decrease value in setting menu.
	Left	1) Screen scroll; 2) Left move cursor in setting menu.
	Right	1) Screen scroll; 2) Right move cursor in setting menu.
	Set/Confirm	1) Pressing and holding for more than 3 seconds enters parameter setting menu; 2) In settings menu confirms the set value.
	Exit	1) Return to main menu; 2) Return to previous menu in setting menu.

**⚠ WARNING:** Default password is 00318, user can change it in case of others change the advanced parameters setting. Please clearly remember the password after changing. If you forget it, please contact Smartgen services and send all PD information in the controller page of “**ABOUT**” to us.

## 4.3 LCD DISPLAY

### 4.3.1 MAIN DISPLAY

Main screen show pages; use   to scroll the pages and   to scroll the screen.

★**Main Screen**, including as below,

Bus 1: voltage, frequency, active power, reactive power

Bus 2: voltage, frequency, active power, reactive power

Some status

★**Status**, including as below,

Module status, ATS status

★**SNYC**, including as below,

Voltage difference, frequency difference, angle difference, MSC status

★**Alarm**

Display all alarm information (warning alarm, trip alarm).

★**Event log**

Make records about all events (trip alarm, power on events and Bus switch events) and the real time when events occur.

★**Others**, including,

Time and Date, input/output ports status.

★**About**, including,

Issue time of software and hardware version, product PD number.

### 4.3.2 USER MENU AND PARAMETERS SETTING MENU

Press  key for more than 3s to enter into user manual.

★**Parameter**

After entering the correct password (factory default password is 00318) you can enter parameter settings screen.

★**Language**

Selectable Chinese, English and others (default: Espanol)

Parameter setting including as following,

★**Battery setting**

★**Bus settings**

★**Breaker settings**





★**Input port settings**





★**output port settings**





★Module settings



★Synchronization settings







Example:





Return	> Close Delay	Form 1: Use   to scroll settings,  to enter settings (form 2),  to exit settings menu.
Battery setting	> Open Delay	
Bus setting		
<b>Breaker setting</b> >		
Input setting		
Output setting		
Module setting		
Synchronization setting		

Return	> <b>Close Delay</b>	Form 2: Use   to scroll settings,  to enter settings,  to return to previous menu. (form 1)
Battery setting	> Open Delay	
Bus setting		
<b>Breaker setting</b> >		
Input setting		
Output setting		
Module setting		
Synchronization setting		

Return	> Close Delay	Form 3: Use   to scroll settings,  to confirm settings (form 4),  to return to previous menu. (form 1)
Battery setting	> <b>Open Delay</b>	
Bus setting		
<b>Breaker setting</b> >		
Input setting		
Output setting		
Module setting		
Synchronization setting		

> Close Delay		Form 4: Press  to enter settings (form 5),  to return to previous menu. (form 6).
> <b>Open Delay</b>	<b>00003</b>	

> Close Delay	00003	Form 5: Press   to change cursor position,   are used for changing cursor value,  to confirm setting (form 4),  to exit setting (form 4).
> Open Delay		

> Close Delay	00003	Form 6: Use   to scroll settings.  to enter settings (form 4),  to return to previous menu. (form 1).
> Open Delay		

SmartGen

## 4.4 AUTO OPERATION

Auto mode is selected by pressing the  button; a LED besides the button will illuminate to confirm the operation.

1. When remote start input is active:
  - a) If either of the two buses is deactivate, then bus close signal will be initiated and the bus will be paralleled with the other bus;
  - b) If both of Bus 1 and Bus 2 are active, the controller will adjust frequency and voltage to synchronize bus with bus; when synchronism requirements has been achieved, bus close signal will be initiated and the bus will be paralleled with the other bus.
2. When remote start input is deactivate, then bus open relay activate and the bus split from the other bus.

**▲Note:** The bus voltage is regarded as active if it has exceeded the dead bus voltage (the dead bus voltage is configurable); otherwise, it is regarded as deactivate.

## 4.5 MANUAL OPERATION

Manual mode is selected by pressing the  button; a LED besides the button will illuminate to confirm the operation.

1. Press  button:

If either of the two buses is deactivate, then bus close signal will be initiated and the bus will be paralleled with the other bus.

If both of Bus 1 and Bus 2 are active, the controller will adjust frequency and voltage to synchronize bus with bus; when synchronism requirements has been achieved, bus close signal will be initiated and the bus will be paralleled with the other bus.

2. Press  button, then bus open relay activates and the bus split from the other bus.

SmartGen

## 5 PROTECTIONS

### 5.1 WARNING ALARMS

Warnings are not shutdown alarms and do not affect the operation of the gen-set. Warning alarms does not lead to shutdown. Warning alarms types are as follows:

No	Type	Description
1	Battery Over Volt	When the controller detects that the battery voltage has exceeded the pre-set value, it will initiate a warning alarm.
2	Battery Under Volt	When the controller detects that the battery voltage has fallen below the pre-set value, it will initiate a warning alarm.
3	Bus Breaker Fail	When the controller detects that the bus close status is not configured in the input port, it will initiate a warning alarm.
4	Digital Input	When the digit input port is set as User Configured and the action select "Warn", it will initiate a warning alarm.
5	Fail to sync	When the controller does not detect synchronization signal within the pre-set synchronization time, it will initiate a warning alarm.
6	Min Sets Not Reached	When the controller detects fewer modules on the MSC link than the minimum number configured in the unit, it will initiate a warning alarm. There are 2 possible reasons: a) Communication line between the controllers disconnects, which interrupts communication. b) Other parallel gen-sets controllers have not been powered on.

## 5.2 TRIP ALARM

On initiation of the trip condition the controller will de-energize the 'Close Generator' Output without stop the generator.

Trip alarm as following,

No	Type	Description
1	Digital Input	When the digit input port is set as User Configured and the action select "Trip", it will initiate a trip alarm.
2	Fail to sync	When the controller does not detect synchronization signal within the pre-set synchronization time, it will initiate a trip alarm.
3	Bus Breaker Fail	When the controller detects that the bus breaker is failed, it will initiate a trip alarm.
4	MSC Too Few Sets	When the controller detects fewer modules on the MSC link than the minimum number configured in the unit, it will initiate a trip alarm. There are 2 possible reasons: a) Communication line between the controllers disconnects, which interrupts communication. b) Other parallel gen-sets controllers have not been powered on.
5	Bus 1 Phase Sequence Wrong	When the controller detects a bus 1 phase rotation error, it will initiate a trip alarm.
6	Bus 2 Phase Sequence Wrong	When the controller detects a bus 2 phase rotation error, it will initiate a trip alarm.
7	MSC ID Error	When the controller detects the same ID on the MSC Bus, it will initiate a trip alarm.
8	Volt Bus Error	When the controller detects that the genset has already closed but there is no voltage on bus, it will initiate a trip alarm.



## 6 WIRING CONNECTION

HGM9580 controller's rear as following:

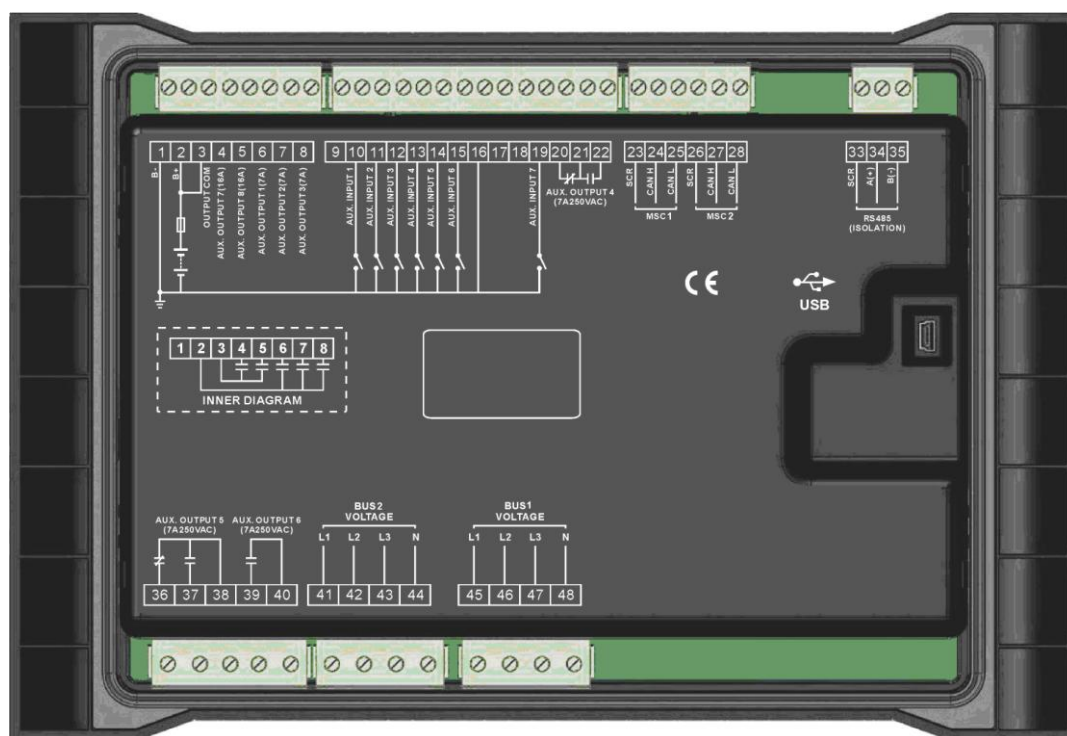

Description of terminal connection:

NO.	Functions	Cable Size	Remark	
1	DC input B-	2.5mm <sup>2</sup>	Connected with negative of starter battery.	
2	DC input B+	2.5mm <sup>2</sup>	Connected with positive of starter battery. If wire length is over 30m, better to double wires in parallel. Max. 20A fuse is recommended.	
3	COM Output 7,8	2.5mm <sup>2</sup>	Connected with B+.	
4	Aux. output 7	1.5mm <sup>2</sup>	B+ is supplied by 3 point, rated 16A.	
5	Aux. output 8	1.5mm <sup>2</sup>	B+ is supplied by 3 point, rated 16A.	
6	Aux. output 1	1.5mm <sup>2</sup>	B+ is supplied by 2 point, rated 7A.	Details see form 2.
7	Aux. output 2	1.5mm <sup>2</sup>	B+ is supplied by 2 point, rated 7A.	
8	Aux. output 3	1.5mm <sup>2</sup>	B+ is supplied by 2 point, rated 7A.	
9	Reserved	/	This is reserved terminals, do not connect to wire.	
10	Aux. input 1	1.0mm <sup>2</sup>	Ground connected is active (B-)	Details see form 3.
11	Aux. input 2	1.0mm <sup>2</sup>	Ground connected is active (B-)	
12	Aux. input 3	1.0mm <sup>2</sup>	Ground connected is active (B-)	

HGM9580 BUS TIE BUS PARALLEL UNIT

NO.	Functions	Cable Size	Remark	
13	Aux. input 4	1.0mm <sup>2</sup>	Ground connected is active (B-)	
14	Aux. input 5	1.0mm <sup>2</sup>	Ground connected is active (B-)	
15	Aux. input 6	1.0mm <sup>2</sup>	Ground connected is active (B-)	
16	Input COM	/		
17-18	Reserved	/	This is reserved terminals, do not connect to wire.	
19	Aux. input 7	1.0mm <sup>2</sup>	Ground connected is active (B-)	Details see form 3.
20	Aux. output 4	1.5mm <sup>2</sup>	Normally close outputs, rated 7A.	Details see form 2.
21			Public points of relay	
22			Normally open outputs, rated 7A.	
23	MSC1 CAN	/	Impedance-120Ω shielding wire is recommended, its single-end earthed.	
24	MSC1 CAN H	0.5mm <sup>2</sup>		
25	MSC1 CAN L	0.5mm <sup>2</sup>		
26	MSC2 CAN	/	Impedance-120Ω shielding wire is recommended, its single-end earthed.	
27	MSC2 CAN H	0.5mm <sup>2</sup>		
28	MSC2 CAN L	0.5mm <sup>2</sup>		
33	RS485	/	Impedance-120Ω shielding wire is recommended, its single-end earthed.	
34	RS485+	0.5mm <sup>2</sup>		
35	RS485-	0.5mm <sup>2</sup>		
36	Aux. output 5	2.5mm <sup>2</sup>	Normally close outputs, rated 7A.	Details see form 2.
37		2.5mm <sup>2</sup>	Normally open outputs, rated 7A.	
38		2.5mm <sup>2</sup>	Public points of relay	
39	Aux. output 6	2.5mm <sup>2</sup>	Normally open outputs, rated 7A.	
40		2.5mm <sup>2</sup>	Public points of relay	
41	Bus 2 A-phase voltage sensing input	1.0mm <sup>2</sup>	Connected to A-phase of Bus 2 (2A fuse is recommended).	
42	Bus 2 B-phase voltage sensing input	1.0mm <sup>2</sup>	Connected to B-phase of Bus 2 (2A fuse is recommended).	
43	Bus 2 C-phase voltage sensing input	1.0mm <sup>2</sup>	Connected to C-phase of Bus 2 (2A fuse is recommended).	
44	Bus 2 N-wire input	1.0mm <sup>2</sup>	Connected to N-wire of Bus 2.	
45	Bus 1 A-phase voltage sensing input	1.0mm <sup>2</sup>	Connected to A-phase of Bus 1 (2A fuse is recommended).	
46	Bus 1 B-phase voltage sensing input	1.0mm <sup>2</sup>	Connected to B-phase of Bus 1 (2A fuse is recommended).	

## HGM9580 BUS TIE BUS PARALLEL UNIT

NO.	Functions	Cable Size	Remark
47	Bus 1 C-phase voltage sensing input	1.0mm <sup>2</sup>	Connected to C-phase of Bus 1 (2A fuse is recommended).
48	Bus 1 N-wire input	1.0mm <sup>2</sup>	Connected to N-wire of Bus 1.

**▲ NOTE:** USB ports in controller rear panel are configurable parameter ports, user can directly program controller via PC.

SmartGen

## 7 SCOPES AND DEFINITIONS OF PROGRAMMABLE PARAMETERS

### 7.1 CONTENTS AND SCOPES OF PARAMETERS

#### Form 1

No.	Items	Parameters	Defaults	Description
<b>Battery Setting</b>				
1	Rated Voltage	(0-60.0)V	24.0	Standard for checking battery over/under voltage.
2	Over Voltage	(0-200)%	120%	Setting value is rated voltage's percentage, return value (default: 115%) and delay value (default: 60s) can be set.
3	Under Voltage	(0-200)%	85%	Setting value is rated voltage's percentage, return value (default: 90%) and delay value (default: 60s) can be set.
<b>Bus Setting</b>				
1	AC System	(0~3)	0	0: 3P4W; 1: 3P3W; 2: 2P3W; 3: 1P2W.
2	Volt. Trans.(PT)	(0-1)	0	0: Disable; 1:Enable
<b>Switch Setting</b>				
1	Close Time	(0~20.0)s	5.0	Pulse width of switch on. When it is 0, means output constantly.
2	Open Time	(0~20.0)s	3.0	Pulse width of switch off.
<b>Module Setting</b>				
1	Power On Mode	(0~1)	0	<b>0:</b> Manual mode <b>1:</b> Auto mode
2	Module Address	(1~254)	1	Controller's address during remote sensing.
3	Stop Bit	(0~1)	0	0: 2 stop bits; 1: 1 stop bit
4	Language	(0~2)	0	0: Simplified Chinese 1: English 2: Others
5	Password	(0~65535)	00318	For entering advanced parameters setting.
<b>Flexible Input Ports</b>				
Flexible Input Port 1				
1	Contents Setting	(0~50)	28	Remote OnLoad. See form 3
2	Active Type	(0~1)	0	0: Closed to active 1: Open to active
Flexible Input Port 2				
1	Contents Setting	(0~50)	0	User defined. See form 3
2	Active Type	(0~1)	0	0: Closed to active 1: Open to active
3	Arming	(0~2)	2	0: From paralleling 1: Always 2:Never

## HGM9580 BUS TIE BUS PARALLEL UNIT

No.	Items	Parameters	Defaults	Description
4	Active Actions	(0~2)	2	0: Warn; 1: Trip 2: Indication
5	Active Delay	(0~20.0)s	2.0	Time from detecting active to confirm
6	Description			LCD display detailed contents when the input is active.
Flexible Input Port 3				
1	Contents Setting	(0~50)	0	User defined. See form 3
2	Active Type	(0~1)	0	0: Closed to active 1: Open to active
3	Arming	(0~2)	2	0: From paralleling 1: Always 2: Never
4	Active Actions	(0~2)	2	0: Warn; 1: Trip 2: Indication
5	Active Delay	(0~20.0)s	2.0	Time from detecting active to confirm
6	Description			LCD display detailed contents when the input is active.
Flexible Input Port 4				
1	Contents Setting	(0~50)	13	Bus Closed. See form 3
2	Active Type	(0~1)	0	0: Closed to active 1: Open to active
Flexible Input Port 5				
1	Contents Setting	(0~50)	0	User defined. See form 3
2	Active Type	(0~1)	0	0: Closed to active 1: Open to active
3	Arming	(0~2)	2	0: From paralleling 1: Always 2: Never
4	Active Actions	(0~2)	2	0: Warn; 1: Trip 2: Indication
5	Active Delay	(0~20.0)s	2.0	Time from detecting active to confirm
6	Description			LCD display detailed contents when the input is active.
Flexible Input Port 6				
1	Contents Setting	(0~50)	0	User defined. See form 3
2	Active Type	(0~1)	0	0: Closed to active 1: Open to active
3	Arming	(0~2)	2	0: From paralleling 1: Always 2: Never
4	Active Actions	(0~2)	2	0: Warn; 1: Trip 2: Indication
5	Active Delay	(0~20.0)s	2.0	Time from detecting active to confirm
6	Description			LCD display detailed contents when the input is active.
Flexible Input Port 7				
1	Contents Setting	(0~50)	0	User defined. See form 3
2	Active Type	(0~1)	0	0: Closed to active 1: Open to active
3	Arming	(0~2)	2	0: From paralleling 1: Always 2: Never
4	Active Actions	(0~2)	2	0: Warn; 1: Trip 2: Indication
5	Active Delay	(0~20.0)s	2.0	Time from detecting active to confirm
6	Description			LCD display detailed contents when the input is active.

No.	Items	Parameters	Defaults	Description
<b>Flexible Output Ports</b>				
Flexible Output Port 1				
1	Contents Setting	(0~239)	44	Bus 1 OK. See Form 2
2	Active Type	(0~1)	0	0:Normally open; 1:Normally close
Flexible Output Port 2				
1	Contents Setting	(0~239)	48	Common Alarm. See Form 2
2	Active Type	(0~1)	0	0:Normally open; 1:Normally close
Flexible Output Port 3				
1	Contents Setting	(0~239)	46	Bus 2 OK. See form 2
2	Active Type	(0~1)	0	0:Normally open; 1:Normally close
Flexible Output Port 4				
1	Contents Setting	(0~239)	47	Synchronizing. See form 2
2	Active Type	(0~1)	0	0:Normally open; 1:Normally close
Flexible Output Port 5				
1	Contents Setting	(0~239)	30	Open Bus Output. See form 2
2	Active Type	(0~1)	0	0:Normally open; 1:Normally close
Flexible Output Port 6				
1	Contents Setting	(0~239)	29	Close Bus Output. See form 2
2	Active Type	(0~1)	0	0:Normally open; 1:Normally close
Flexible Output Port 7				
1	Contents Setting	(0~239)	0	Not Used. See form 2
2	Active Type	(0~1)	0	0:Normally open; 1:Normally close
Flexible Output Port 8				
1	Contents Setting	(0~239)	0	Not Used. See form 2
2	Active Type	(0~1)	0	0:Normally open; 1:Normally close
Sync Setting				
1	MSC ID	(0-31)	1	It is the ID mark of the MSC communication internet. All the MSC ID should be unique.
2	Dead Bus Volt	(10-50)V	30	It is considered Bus no power when Bus voltage is lower than dead Bus voltage.
3	Slip Frequency	(0-1.00)Hz	0.10	Adjust bus frequency and enable it greater than the other bus frequency. When slip frequency is 0: If the frequency difference is greater than 0.1Hz, then the frequency will be

HGM9580 BUS TIE BUS PARALLEL UNIT

No.	Items	Parameters	Defaults	Description
				synchronized; If the frequency difference is smaller than 0.1Hz, then the phase will be synchronized;
4	Voltage Difference	(0-30)V	3	The voltage difference between bus 1 and bus 2. It is considered voltage synchronization when the voltage difference between Bus 1 and Bus 2 is lower than synchronization voltage difference.
5	Positive Freq Difference	(0-2.0)Hz	0.2	The frequency difference between bus 1 and bus 2. It is considered frequency synchronization when the frequency difference between bus 1 and bus 2 is less than Positive Freq Difference but more than Negative Freq Difference.
6	Negative Freq Difference	(0-2.0)Hz	0.1	
7	Phase Angle Difference	(0-20)°	10	Initial phase difference between bus 1 and bus 2. It is considered Check Phase Angle when the initial phase difference is lower than synchronization phase difference.
8	Fail to Sync Delay	(5.0-300.0)s	60.0	When the controller detects no Sync signal during the preset delay, it will send corresponding alarm signal according to the action type. Action Type: 0: Warn; 1: Trip.
9	Fail to Sync Action	(0-1)	0	
10	Sync Freq Gain	(0~500)	20	Adjust and control before paralleling.
11	Sync Freq Stab.	(0~2000)	20	Adjust and control before paralleling.
12	Sync Volt Gain	(0~500)	20	Adjust and control before paralleling.
13	Sync Volt Stab.	(0~2000)	20	Adjust and control before paralleling.
14	MSC Number	(1-32)	2	
15	Too Few Modules Action	(0-2)	1	Action Type: 0: No Action; 1: Warn; 2: Trip.
16	Baud Rate	(0-3)	1	0: 500Kbit/s; 1: 250Kbit/s; 2: 125Kbit/s; 3: 50Kbit/s.



## 7.2 ENABLE DEFINITION OF PROGRAMMABLE OUTPUT PORTS

### Form 2

No.	Type	Description
0	Not Used	
1~6	Reserved	
7	Custom Combined 1	Details of function description please see the following.
8	Custom Combined 2	
9	Custom Combined 3	
10	Custom Combined 4	
11	Custom Combined 5	
12	Custom Combined 6	
13~17	Reserved	
18	Audible Alarm	Action when warning, trips. Can be connected annunciator externally. When "alarm mute" configurable input port is active, it can remove the alarm.
19~25	Reserved	
26	Remote Control Output	This port is controlled by communication (PC).
27~28	Reserved	
29	Close Bus Output	Control bus to take load.
30	Open Bus Output	Control bus to off load.
31~43	Reserved	
44	Bus 1 OK	Action when bus 1 is normal.
45	Reserved	
46	Bus 2 OK	Action when bus 2 is normal.
47	Synchronizing	Action when controller is synchronizing.
48	Common Alarm	Action when genset common warning or common trips alarm.
49	Reserved	
50	Reserved	
51	Common Trip	Action when common trips alarm.
52	Common Warn	Action when common warning alarm.
53	Reserved	
54	Battery Over Voltage	Action when battery's over voltage warning alarm.
55	Battery Under Voltage	Action when battery's low voltage warning alarm.
56~68	Reserved	
69	Digital Input 1 Active	Action when input port 1 is active
70	Digital Input 2 Active	Action when input port 2 is active
71	Digital Input 3 Active	Action when input port 3 is active
72	Digital Input 4 Active	Action when input port 4 is active
73	Digital Input 5 Active	Action when input port 5 is active
74	Digital Input 6 Active	Action when input port 6 is active
75	Digital Input 7 Active	Action when input port 7 is active
76~230	Reserved	
231	Manual Mode	Action in Manual mode.
232	Reserved	



## HGM9580 BUS TIE BUS PARALLEL UNIT

233	Auto Mode	Action in Auto mode.
234	Bus Load	
235~239	Reserved	

SmartGen

### 7.2.1 DEFINED COMBINATION OUTPUT

Defined combination output is composed by 3 parts, condition output S1 or S2 and condition output S3.

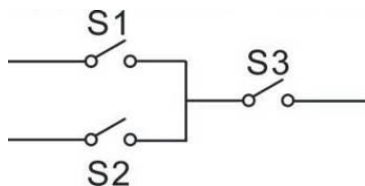

S1 or S2 is **TRUE**, while S3 is **TRUE**, Defined combination output is outputting;  
S1 and S2 are **FALSE**, or S3 is **FALSE**, Defined combination output is not outputting.

▲**NOTE:** S1, S2, S3 can be set as any contents except for “defined combination output” in the output setting.

▲**NOTE:** 3 parts of defined combination output (S1, S2, S3) couldn't include or recursively include themselves.

Example,

Contents of probably condition output S1: output port 1 is active;

Close when probably condition output S1 is active /inactive: close when active (disconnect when inactive);

Contents of probably condition output S2, output port 2 is active;

Close when probably condition output S2 is active /inactive: close when active (disconnect when inactive);

Contents of probably condition output S3: output port 3 is active;





Close when probably condition output S3 is active /inactive: close when active (disconnect when inactive);

When input port 1 active or input port 2 active, if input port 3 is active, Defined combination output is outputting; If input port 3 inactive, Defined combination output is not outputting;

When input port 1 inactive and input port 2 inactive, whatever input port 3 is active or not, Defined combination output is not outputting.

## 7.3 DEFINED CONTENTS OF PROGRAMMABLE INPUT PORTS (ALL ACTIVE WHEN CONNECT TO GRAND (B~))

### Form 3

No.	Type	Description
0	Users Configured	Including following functions, Indication: indicate only, not warning or shutdown. Warning: warn only. Trip: alarm, generator unloads but not shutdown. Never: input inactive. Always: input is active all the time. From paralleling: detect when the genset is parallel running.
1	Reserved	
2	Alarm Mute	Can prohibit "Audible Alarm" output when input is active.
3	Reset Alarm	Can reset trip alarm when input is active.
4	Reserved	
5	Lamp Test	All LED indicators are illuminating when input is active.
6	Panel Lock	All buttons in panel is inactive except  and there is  in the right of first row in LCD when input is active.
7~12	Reserved	
13	Aux Bus Closed	Connect bus loading switch's Aux. Point.
14	Inhibit Bus Load	Prohibit bus switch on when input is active.
15~16	Reserved	
17	Auto Mode Lock	When input is active, controller enters into Auto mode;  button is inactive.
18	Auto Mode Invalid	When input is active, controller won't work under Auto mode.  key and simulate auto key input does not work.
19~21	Reserved	
22	Aux Instrument Mode	All outputs are prohibited in this mode.
23~27	Reserved	
28	Remote Start (On Load)	In <b>Auto</b> mode, when the input is active, bus can be paralleled automatically; when the input is inactive, bus will split automatically.
29~33	Reserved	
34	Simulate Manual key	An external button (not self-locking) can be connected and pressed as simulate panel.
35	Reserved	

## HGM9580 BUS TIE BUS PARALLEL UNIT

36	Simulate Auto key	An external button (not self-locking) can be connected and pressed as simulate panel.
37	Reserved	
38	Simulate Close Button	An external button (not self-locking) can be connected and pressed as simulate panel.
39	Simulate Open Button	
40~50	Reserved	

SmartGen

## 8 TYPICAL DIAGRAM

HGM9580 Typical Diagram

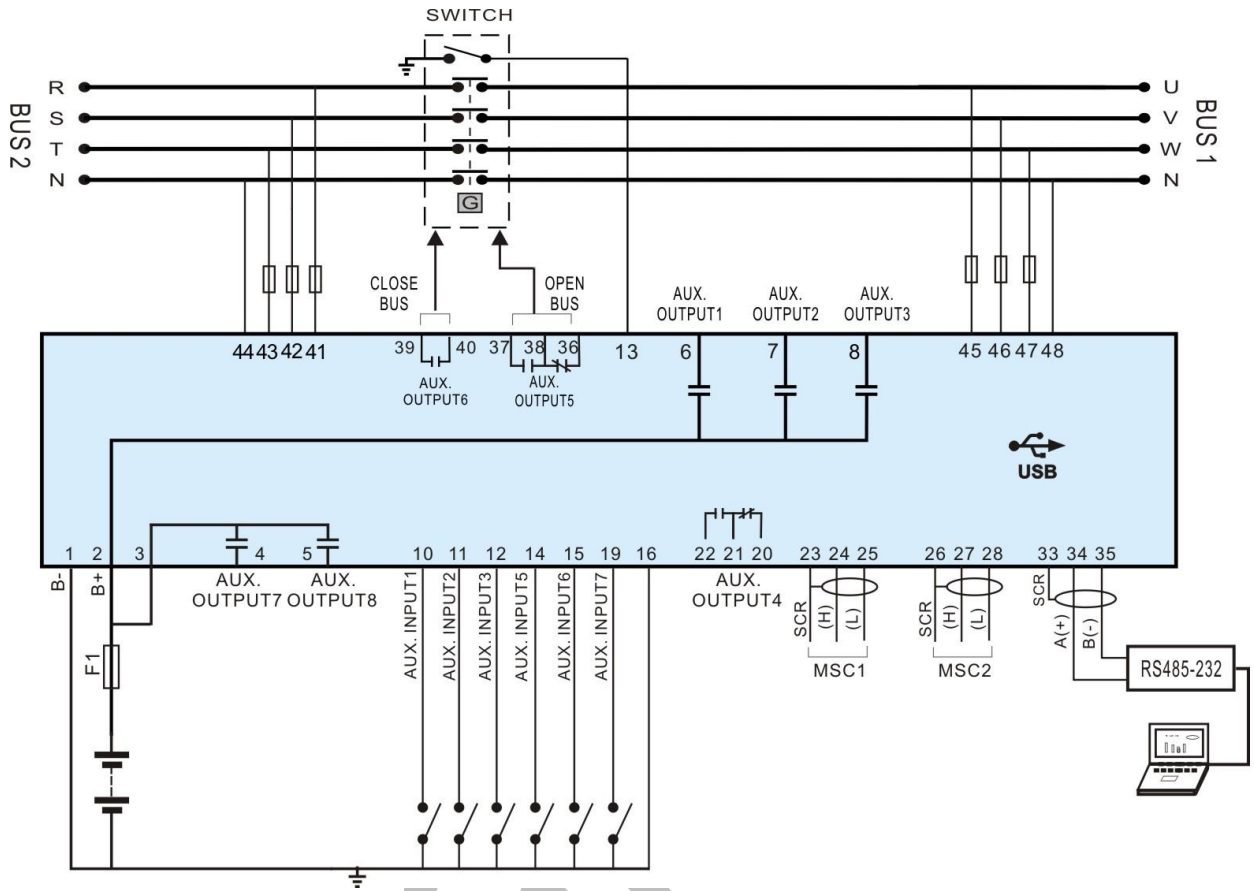

## 9 TYPICAL APPLICATION

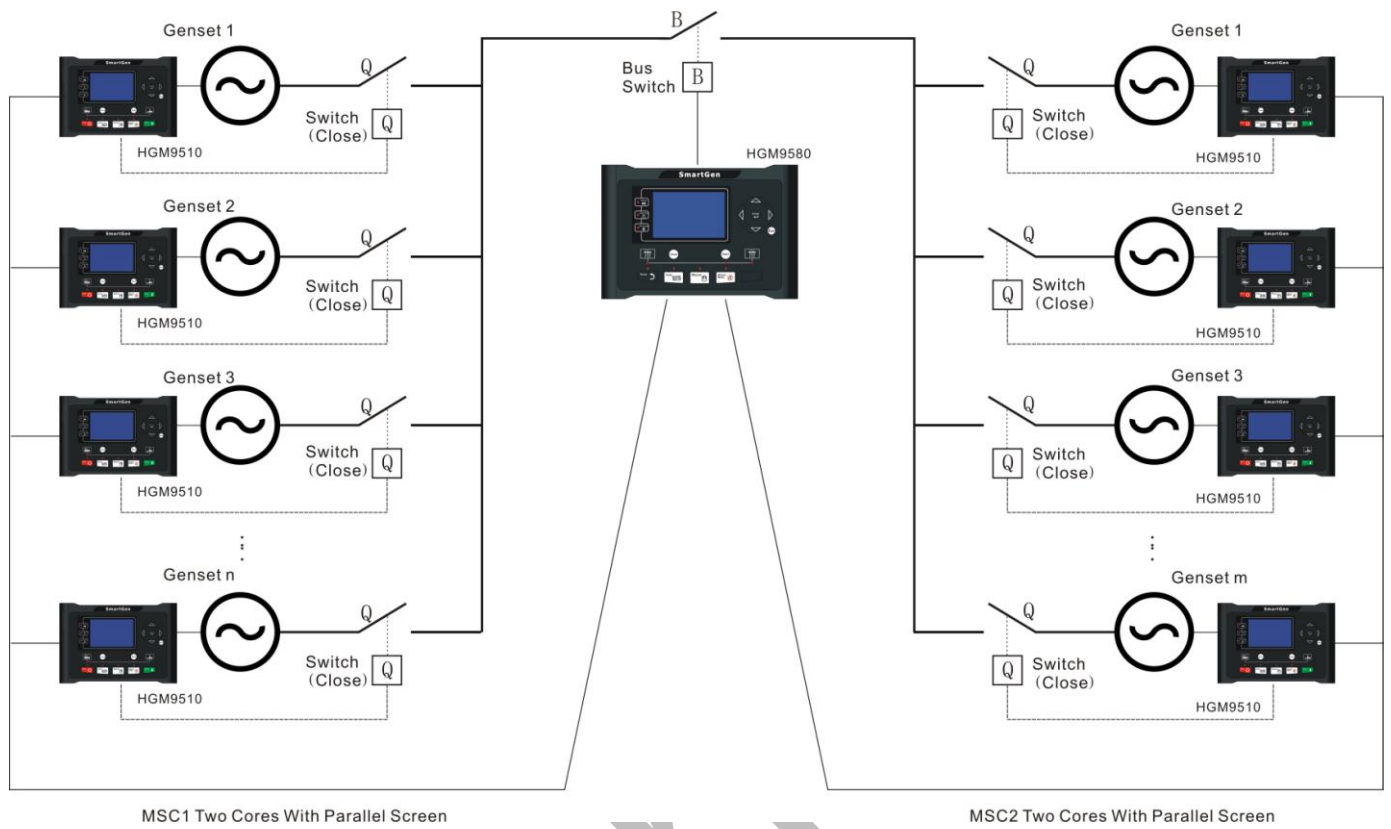

SmartGen

## 10 INSTALLATION

Controller is panel built-in design; it is fixed by clips when installed. The controller's overall dimensions and cutout dimensions for panel, please refers to as following,

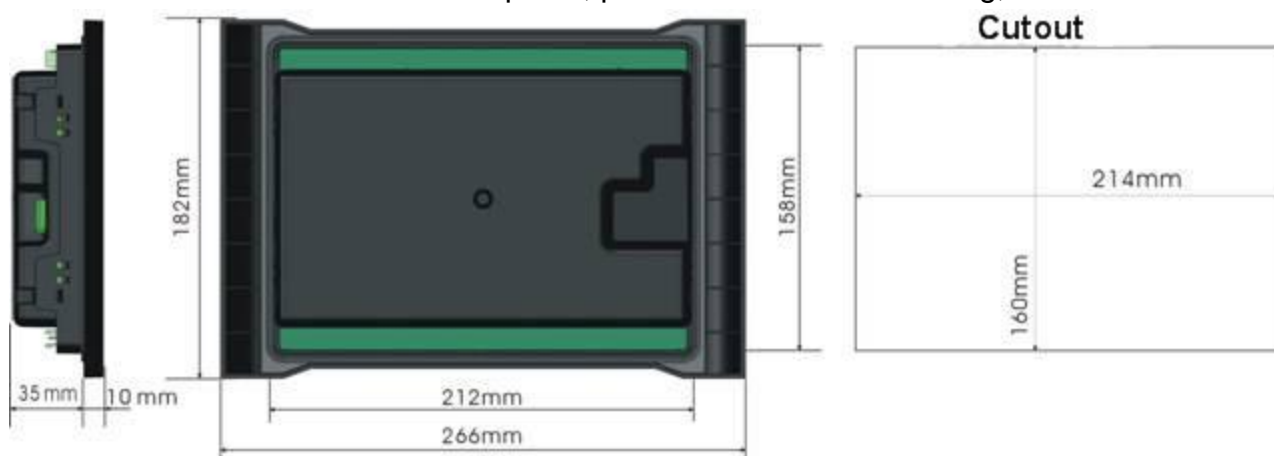

### 1) Battery Voltage Input

**NOTE:** HGM9580 controller can suit for widely range of battery voltage DC(8~35)V. Negative of battery must be connected with the engine shell. The diameter of wire which from power supply to battery must be over 2.5mm<sup>2</sup>. If floating charge configured, please firstly connect output wires of charger to battery's positive and negative directly, then, connect wires from battery's positive and negative to controller's positive and negative input ports in order to prevent charge disturbing the controller's normal working.

### 2) Output And Expand Relays

**CAUTION:** All outputs of controller are relay contact output type. If need to expand the relays, please add freewheel diode to both ends of expand relay's coils (when coils of relay has DC current) or, add resistance-capacitance return circuit (when coils of relay has AC current), in order to prevent disturbance to controller or others equipment.

### 3) Withstand Voltage Test

**CAUTION!** When controller had been installed in control panel, if need the high voltage test, please disconnect controller's all terminal connections, in order to prevent high voltage into controller and damage it.

## 11 USB

Users can set the controller's parameters and monitor the controller's status via the test software which provided by Smartgen company. The connection way between PC and controller as following:





**12 FAULT FINDING**

Symptoms	Possible Solutions
Controller no response with power.	Check starting batteries; Check controller connection wirings; Check DC fuse.
Shutdown Alarm in running	Check related switch and its connections according to the information on LCD; Check auxiliary input ports.
Genset running while ATS not transfer	Check ATS; Check the connections between ATS and controllers.
RS485 communication is abnormal	Check connections; Check setting of COM port is correct or not; Check RS485's connections of A and B is reverse connect or not; Check RS485 transfer module whether damage or not; Check communication port of PC whether damage.

SmartGen