



DEEP SEA ELECTRONICS PLC DSE6010 MKII & DSE6020 MKII Operator Manual

Document Number: 057-230

Author: Mark Graham



DEEP SEA ELECTRONICS PLC

Highfield House
Hunmanby
North Yorkshire
YO14 0PH
ENGLAND



Sales Tel: +44 (0) 1723 890099
Sales Fax: +44 (0) 1723 893303

E-mail: sales@deepseapl.com
Website: www.deepseapl.com

DSE6010 MKII & DSE6020 MKII Operator Manual

© Deep Sea Electronics Plc

All rights reserved. No part of this publication may be reproduced in any material form (including photocopying or storing in any medium by electronic means or other) without the written permission of the copyright holder except in accordance with the provisions of the Copyright, Designs and Patents Act 1988.

Applications for the copyright holder's written permission to reproduce any part of this publication should be addressed to Deep Sea Electronics Plc at the address above.

The DSE logo is a UK registered trademarks of Deep Sea Electronics PLC.

Any reference to trademarked product names used within this publication is owned by their respective companies.

Deep Sea Electronics Plc reserves the right to change the contents of this document without prior notice.

Amendments List

Issue	Comments	Minimum Module Version Required	Minimum Configuration Suite Version required
1	Initial release	V 1.0.0	2014.103 V 2.17.3

Typeface: The typeface used in this document is *Arial*. Care should be taken not to mistake the upper case letter I with the numeral 1. The numeral 1 has a top serif to avoid this confusion.

Clarification of notation used within this publication.



 NOTE	Highlights an essential element of a procedure to ensure correctness.
 CAUTION!	Indicates a procedure or practice, which, if not strictly observed, could result in damage or destruction of equipment.
 WARNING!	Indicates a procedure or practice, which could result in injury to personnel or loss of life if not followed correctly.

TABLE OF CONTENTS

Section	Page
1 INTRODUCTION.....	7
1.1 BIBLIOGRAPHY	8
1.1.1 INSTALLATION INSTRUCTIONS.....	8
1.1.2 TRAINING GUIDES.....	8
1.1.3 MANUALS	8
1.1.4 THIRD PARTY DOCUMENTS	8
2 SPECIFICATION.....	9
2.1 SHORT NAMES	9
2.2 OPERATING TEMPERATURE	9
2.2.1 SCREEN HEATER OPERATION.....	9
2.3 REQUIREMENTS FOR UL CERTIFICATION	9
2.4 TERMINAL SPECIFICATION.....	10
2.5 POWER SUPPLY REQUIREMENTS.....	10
2.5.1 MODULE SUPPLY INSTRUMENTATION DISPLAY	10
2.6 VOLTAGE & FREQUENCY SENSING	11
2.7 CURRENT SENSING	11
2.7.1 VA RATING OF THE CTS.....	12
2.7.2 CT POLARITY	13
2.7.3 CT PHASING.....	13
2.7.4 CT CLASS	13
2.8 INPUTS.....	14
2.8.1 DIGITAL INPUTS	14
2.8.2 ANALOGUE INPUTS	14
2.8.2.1 OIL PRESSURE.....	14
2.8.2.2 COOLANT TEMPERATURE.....	14
2.8.2.3 FUEL LEVEL SENSOR.....	15
2.8.2.4 FLEXIBLE SENSOR	15
2.8.2.4.1 RESISTIVE CONFIGURATION.....	15
2.8.2.4.2 0-10V INPUT CONFIGURATION	15
2.8.2.4.3 4-20 MA INPUT CONFIGURATION	15
2.8.3 CHARGE FAIL INPUT.....	16
2.8.4 MAGNETIC PICKUP	17
2.9 OUTPUTS.....	17
2.9.1 DC OUTPUTS A & B (FUEL & START).....	17
2.9.2 CONFIGURABLE DC OUTPUTS C, D, E & F	17
2.10 COMMUNICATION PORTS	18
2.10.1 CAN INTERFACE.....	18
2.10.2 USB CONNECTION.....	19
2.11 ADDING AN EXTERNAL SOUNDER.....	20
2.12 ACCUMULATED INSTRUMENTATION	20
2.13 DIMENSIONS AND MOUNTING	21
2.13.1 DIMENSIONS.....	21
2.13.2 PANEL CUTOUT.....	21
2.13.3 WEIGHT	21
2.13.4 FIXING CLIPS	22
2.13.5 SILICON SEALING GASKET	23
2.13.6 APPLICABLE STANDARDS	24
2.13.7 ENCLOSURE CLASSIFICATIONS	26
2.13.7.1 IP CLASSIFICATIONS.....	26
2.13.7.2 NEMA CLASSIFICATIONS.....	27
3 INSTALLATION	28
3.1 TERMINAL DESCRIPTION.....	28
3.1.1 DC SUPPLY, ESTOP INPUT, DC OUTPUTS & CHARGE FAIL INPUT	29
3.1.2 ANALOGUE SENSORS, MPU & CAN	30

3.1.3	GENERATOR / MAINS VOLTAGE & FREQUENCY SENSING	31
3.1.4	CURRENT TRANSFORMERS.....	31
3.1.4.1	CT CONNECTIONS.....	32
3.1.5	CONFIGURABLE DIGITAL INPUTS.....	32
3.1.6	PC CONFIGURATION INTERFACE CONNECTOR	33
3.2	TYPICAL WIRING DIAGRAM	34
3.2.1	DSE6010 MKII TYPICAL WIRING DIAGRAM (3 PHASE 4 WIRE)	35
3.2.2	DSE6020 MKII TYPICAL WIRING DIAGRAM (3 PHASE 4 WIRE)	36
3.3	ALTERNATE TOPOLOGY WIRING DIAGRAMS.....	37
3.3.1	GENERATOR.....	37
3.3.2	MAINS (6020 MKII ONLY).....	38
3.4	EARTH SYSTEMS	39
3.4.1	NEGATIVE EARTH.....	39
3.4.2	POSITIVE EARTH.....	39
3.4.3	FLOATING EARTH.....	39
4	DESCRIPTION OF CONTROLS.....	40
4.1	DSE6010 MKII.....	41
4.2	DSE6020 MKII.....	42
4.3	CONTROL PUSH-BUTTONS	43
4.4	MODULE DISPLAY.....	46
4.4.1	BACKLIGHT	47
4.4.2	INSTRUMENTATION ICONS	47
4.4.3	ACTIVE CONFIGURATION	48
4.4.4	FRONT PANEL EDITOR (FPE) / AUTO RUN ICON	48
4.4.5	MODE ICON.....	48
4.4.6	ALARM ICONS (PROTECTIONS)	49
4.4.6.1	WARNING ALARM ICONS.....	50
4.4.6.2	ELECTRICAL TRIP ALARM ICONS	51
4.4.6.3	SHUTDOWN ALARM ICONS	52
4.5	VIEWING THE INSTRUMENT PAGES.....	54
4.5.1	NAVIGATION MENU.....	54
4.5.1.1	NAVIGATION MENU ICONS	54
4.5.2	GENERAL NAVIGATION	55
4.5.3	HOME.....	56
4.5.4	GENERATOR.....	56
4.5.5	MAINS (DSE6020 MKII ONLY)	57
4.5.6	LOAD.....	57
4.5.7	ENGINE.....	58
4.5.8	INFO	58
4.5.9	ENGINE DTC (ECU ALARMS).....	59
4.5.9.1	VIEWING ACTIVE ENGINE DTC	59
4.5.10	EVENT LOG.....	61
4.5.10.1	VIEWING THE EVENT LOG.....	62
5	OPERATION.....	63
5.1	QUICKSTART GUIDE.....	63
5.1.1	STARTING THE ENGINE	63
5.1.2	STOPPING THE ENGINE.....	64
5.2	STOP/RESET MODE	65
5.3	MANUAL MODE.....	66
5.3.1	STARTING SEQUENCE	66
5.3.2	ENGINE RUNNING.....	67
5.3.3	STOPPING SEQUENCE.....	67
5.4	TEST MODE.....	68
5.4.1	STARTING SEQUENCE	68
5.4.2	ENGINE RUNNING.....	69
5.4.3	STOPPING SEQUENCE.....	69
5.5	AUTOMATIC MODE	70
5.5.1	WAITING IN AUTO MODE	70
5.5.2	STARTING SEQUENCE	70

5.5.3	ENGINE RUNNING	71
5.5.4	STOPPING SEQUENCE	71
5.6	MAINTENANCE ALARM.....	72
5.7	SCHEDULER.....	73
5.7.1	STOP MODE	73
5.7.2	MANUAL MODE	73
5.7.3	TEST MODE.....	73
5.7.4	AUTO MODE.....	73
6	FRONT PANEL CONFIGURATION.....	74
6.1	ACCESSING THE FRONT PANEL CONFIGURATION EDITOR.....	75
6.2	ADJUSTABLE PARAMETERS.....	76
6.2.1	MODULE SETTINGS	76
6.2.2	CAN SETTINGS.....	76
6.2.3	INPUT SETTINGS.....	77
6.2.4	OUTPUT SETTINGS.....	78
6.2.5	TIMER SETTINGS	78
6.2.6	GENERATOR SETTINGS.....	79
6.2.7	MAINS SETTINGS	80
6.2.8	ENGINE SETTINGS.....	81
6.2.9	ANALOGUE INPUTS SETTINGS	82
6.2.10	SCHEDULER SETTINGS	84
6.2.11	TIME AND DATE SETTINGS.....	84
6.2.12	MAINTENANCE ALARM SETTINGS.....	85
6.2.13	ALTERNATE CONFIGURATION SETTINGS.....	85
6.3	SELECTABLE PARAMETER SETTINGS	87
6.3.1	INPUT SOURCES.....	87
6.3.2	OUTPUT SOURCES.....	88
6.3.3	ALARM ACTION.....	90
6.3.4	FLEXIBLE SENSOR ALARM ACTION.....	90
6.3.5	POWER UP MODE	90
6.3.6	SENSOR TYPE	90
6.3.7	AC SYSTEM.....	90
6.3.8	DIGITAL INPUT ALARM ARMING	91
6.3.9	DIGITAL INPUT POLARITY	91
6.3.10	DIGITAL OUTPUT POLARITY.....	91
6.3.11	FUEL UNITS.....	91
6.3.12	PRESSURE SENSOR LIST	92
6.3.13	TEMPERATURE SENSOR LIST.....	92
6.3.14	PERCENTAGE SENSOR LIST	92
7	COMMISSIONING	93
8	FAULT FINDING.....	94
8.1	STARTING.....	94
8.2	LOADING	94
8.3	ALARMS.....	95
8.4	COMMUNICATIONS	95
8.5	INSTRUMENTS.....	95
8.6	MISCELLANEOUS.....	96
9	MAINTENANCE, SPARES, REPAIR AND SERVICING.....	97
9.1	PURCHASING ADDITIONAL CONNECTOR PLUGS FROM DSE.....	97
9.1.1	PACK OF PLUGS.....	97
9.1.2	INDIVIDUAL PLUGS	97
9.2	PURCHASING ADDITIONAL FIXING CLIPS FROM DSE	97
9.3	PURCHASING ADDITIONAL SEALING GASKET FROM DSE.....	97
10	WARRANTY.....	98
11	DISPOSAL	98

11.1 WEEE (WASTE ELECTRICAL AND ELECTRONIC EQUIPMENT).....98

1 INTRODUCTION

This document details the installation and operation requirements of the DSE6010 MKII & DSE6020 MKII modules, part of the DSE Genset® range of products.

The manual forms part of the product and should be kept for the entire life of the product. If the product is passed or supplied to another party, ensure that this document is passed to them for reference purposes.

This is not a *controlled document*. DSE do not automatically inform on updates. Any future updates of this document are included on the DSE website at www.deepseapl.com

The DSE60xx MKII series is designed to provide differing levels of functionality across a common platform. This allows the generator OEM greater flexibility in the choice of controller to use for a specific application.

The DSE60xx MKII series module has been designed to allow the operator to start and stop the generator, and if required, transfer the load to the generator either manually or automatically. Additionally, the DSE6020 MKII automatically starts and stops the generator set depending upon the status of the mains (utility) supply.

The user also has the facility to view the system operating parameters via the LCD display.

The DSE60xx MKII module monitors the engine, indicating the operational status and fault conditions, automatically shutting down the engine and giving a true first up fault condition of an engine failure by the LCD display.

The powerful ARM microprocessor contained within the module allows for incorporation of a range of complex features:

- *Icon based LCD display*
- **True RMS Voltage**
- *Current and Power monitoring*
- *USB Communications*
- *Engine parameter monitoring.*
- *Fully configurable inputs for use as alarms or a range of different functions.*
- *Engine ECU interface to **electronic engines**.*

Using a PC and the DSE Configuration Suite software allows alteration of selected operational sequences, timers, alarms and operational sequences. Additionally, the module's integral front panel configuration editor allows adjustment of this information.

A robust plastic case designed for front panel mounting houses the module. Connections are via locking plug and sockets.

Access to critical operational sequences and timers for use by qualified engineers, can be protected by a security code. Module access can also be protected by PIN code. Selected parameters can be changed from the module's front panel.

The module is housed in a robust plastic case suitable for panel mounting. Connections to the module are via locking plug and sockets.

1.1 BIBLIOGRAPHY

This document refers to and is referred to by the following DSE publications which can be obtained from the DSE website: www.deepseapl.com

1.1.1 INSTALLATION INSTRUCTIONS

Installation instructions are supplied with the product in the box and are intended as a 'quick start' guide only.

DSE Part	Description
053-174	DSE6010 MKII & DSE6020 MKII Installation Instructions

1.1.2 TRAINING GUIDES

Training Guides are produced to give 'handout' sheets on specific subjects during training sessions

DSE Part	Description
056-005	Using CTs With DSE Products
056-010	Over Current Protection
056-022	Breaker Control
056-029	Smoke Limiting
056-030	Module PIN Codes

1.1.3 MANUALS

Product manuals are can be downloaded from the DSE website: www.deepseapl.com

DSE Part	Description
057-004	Electronic Engines and DSE Wiring Guide
057-223	DSE6010 MKII & DSE6020 MKII Configuration Suite PC Software Manual

1.1.4 THIRD PARTY DOCUMENTS

The following third party documents are also referred to:

Reference	Description
ISBN 1-55937-879-4	IEEE Std C37.2-1996 IEEE Standard Electrical Power System Device Function Numbers and Contact Designations. Institute of Electrical and Electronics Engineers Inc
ISBN 0-7506-1147-2	Diesel generator handbook. L.L.J. Mahon
ISBN 0-9625949-3-8	On-Site Power Generation. EGSA Education Committee.

2 SPECIFICATION

2.1 SHORT NAMES

Short Name	Description
DSE6000,DSE6xxx MKII	All modules in the DSE6000 MKII range.
DSE6000,DSE60xx MKII	All modules in the DSE6000 MKII range.
DSE6010 MKII	DSE6010 MKII module/controller
DSE6020 MKII	DSE6020 MKII module/controller

2.2 OPERATING TEMPERATURE

Module	Description
DSE60xx MKII	-30 °C +70 °C (-22 °F +158 °F)
Display Heater Variants	-40 °C +70 °C (-40 °F +158 °F)

2.2.1 SCREEN HEATER OPERATION

Screen Heater Function	Description
Turn On When Temperature Falls Below	-10 °C (+14 °F)
Turn Off When Temperature Rises Above	-5 °C (+23 °F)

2.3 REQUIREMENTS FOR UL CERTIFICATION

Screw Terminal Tightening Torque	4.5 lb-in (0.5 Nm)
Conductors	<ul style="list-style-type: none"> Terminals suitable for connection of conductor size 12 AWG – 26 AWG (0.5mm² to 2.0mm²). Conductor protection must be provided in accordance with NFPA 70, Article 240 Low voltage circuits (35 volts or less) must be supplied from the engine starting battery or an isolated secondary circuit. The communication, sensor, and/or battery derived circuit conductors shall be separated and secured to maintain at least ¼” (6mm) separation from the generator and mains connected circuit conductors unless all conductors are rated 600 Volts or greater.
Current Inputs	Must be connected through UL Listed or Recognized isolating current transformers with the secondary rating of 5A max.
Communication Circuits	Must be connected to communication circuits of UL Listed equipment
Output Pilot Duty	0.5 A
Mounting	<ul style="list-style-type: none"> Suitable for use in type 1 Enclosure Type rating with surrounding air temperature -22 °F to +158 °F (-30 °C to +70 °C) Suitable for pollution degree 3 environments when voltage sensing inputs do not exceed 300V. When used to monitor voltages over 300V device to be install in an unventilated or filtered ventilation enclosure to maintain a pollution degree 2 environment.
Operating Temperature	-22 °F to +158 °F (-30 °C to +70 °C)
Storage Temperature	-40 °F to +176 °F (-40 °C to +80 °C)

2.4 TERMINAL SPECIFICATION

NOTE: For purchasing additional connector plugs from DSE, please see the section entitled **Maintenance, Spares, Repair and Servicing** elsewhere in this document.

Connection Type	Two part connector. <ul style="list-style-type: none"> • Male part fitted to module • Female part supplied in module packing case - Screw terminal, rising clamp, no internal spring. 	 <p>Example showing cable entry and screw terminals of a 10 way connector</p>
Minimum Cable Size	0.5 mm ² (AWG 24)	
Maximum Cable Size	2.5 mm ² (AWG 10)	

2.5 POWER SUPPLY REQUIREMENTS

Minimum Supply Voltage	8 V continuous
Cranking Dropouts	Able to survive 0 V for 100 ms providing the supply was at least 10 V before the dropout and recovers to 5 V afterwards.
Maximum Supply Voltage	35 V continuous (60 V protection)
Reverse Polarity Protection	-35 V continuous
Maximum Operating Current	100 mA at 12 V 105 mA at 24 V
Maximum Standby Current	60 mA at 12 V 55 mA at 24 V
Maximum Current When In Sleep Mode	40 mA at 12 V 35 mA at 24 V
Typical Power (Controller On, Heater Off)	1.2 W to 2.4 W
Typical Power (Controller In Standby, Heater Off)	0.7 W to 1.2 W

2.5.1 MODULE SUPPLY INSTRUMENTATION DISPLAY

Range	0 V to 70 V DC (note Maximum continuous operating voltage of 35 V DC)
Resolution	0.1 V
Accuracy	1 % full scale (± 0.7 V)

2.6 VOLTAGE & FREQUENCY SENSING

Measurement Type	True RMS conversion
Sample Rate	5 kHz or better
Harmonics	Up to 11 th or better
Input Impedance	300 k Ω phase to neutral
Phase To Neutral	15 V (minimum required for sensing frequency) to 415 V AC (absolute maximum) Suitable for 345 V AC nominal (± 20 % for under/overvoltage detection)
Phase To Phase	25 V (minimum required for sensing frequency) to 720 V AC (absolute maximum) Suitable for 600 V AC nominal (± 20 % for under/overvoltage detection)
Common Mode Offset From Earth	100 V AC (max)
Resolution	1 V AC phase to neutral 2 V AC phase to phase
Accuracy	± 1 % of full scale phase to neutral ± 2 % of full scale phase to phase
Minimum Frequency	3.5 Hz
Maximum Frequency	75.0 Hz
Frequency Resolution	0.1 Hz
Frequency Accuracy	± 0.2 Hz

2.7 CURRENT SENSING

Measurement Type	True RMS conversion
Sample Rate	5 KHz or better
Harmonics	Up to 10 th or better
Nominal CT Secondary Rating	5 A
Maximum Continuous Current	5 A
Overload Measurement	3 x Nominal Range setting
Absolute Maximum Overload	50 A for 1 second
Burden	0.25 VA (0.01 Ω current shunts)
Common Mode Offset	± 1 V peak plant ground to CT common terminal
Resolution	0.5 % of 5 A
Accuracy	± 1 % of Nominal (5 A) (excluding CT error)

2.7.1 VA RATING OF THE CTS

NOTE
 : Details for 4 mm² cables are shown for reference only. The connectors on the DSE modules are only suitable for cables up to 2.5 mm².

The VA burden of the module on the CTs is 0.5 VA. However depending upon the type and length of cabling between the CTs and the module, CTs with a greater VA rating than the module are required.

The distance between the CTs and the measuring module should be estimated and cross-referenced against the chart opposite to find the VA burden of the cable itself.

If the CTs are fitted within the alternator top box, the star point (common) of the CTs should be connected to system ground (earth) as close as possible to the CTs. This minimises the length of cable used to connect the CTs to the DSE module.

Example.

If 1.5 mm² cable is used and the distance from the CT to the measuring module is 20 m, then the burden of the cable alone is approximately 15 VA. As the burden of the DSE controller is 0.5 VA, then a CT with a rating of at least $15 + 0.5 \text{ V} = 15.5 \text{ VA}$ must be used. If 2.5 mm² cables are used over the same distance of 20 m, then the burden of the cable on the CT is approximately 7 VA. CT's required in this instance is at least 7.5 VA (7+0.5).

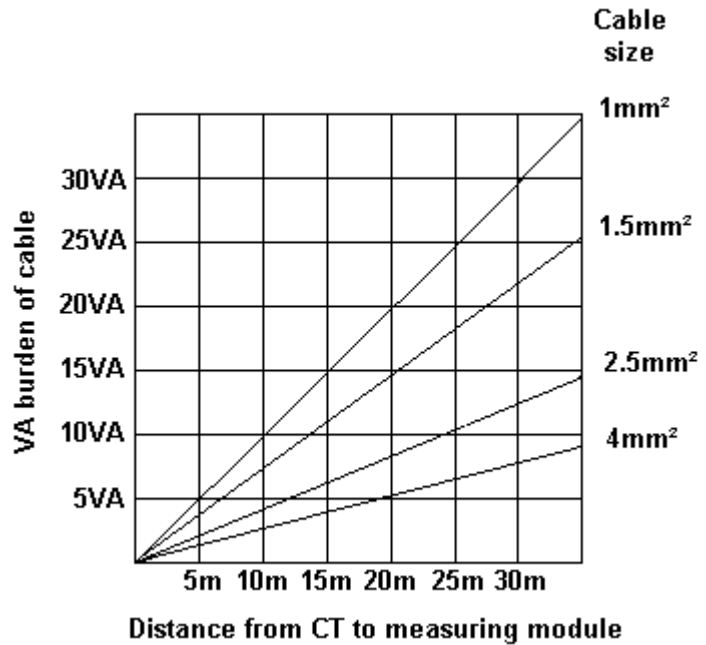

2.7.2 CT POLARITY

NOTE: Take care to ensure correct polarity of the CT primary as shown above. If in doubt, check with the CT supplier.

Take care to ensure the correct polarity of the CTs. Incorrect CT orientation leads to negative kW readings when the set is supplying power. Take note that paper stick-on labels on CTs that show the orientation are often incorrectly placed on the CT (!). It is more reliable to use the labelling in the case moulding as an indicator to orientation (if available).

To test orientation, run the generator in island mode (not in parallel with any other supply) and load the generator to around 10 % of the set rating. Ensure the DSE module shows positive kW for all three individual phase readings.

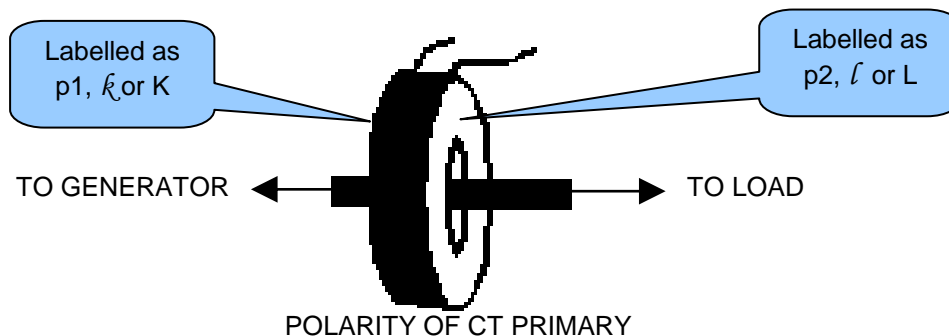

2.7.3 CT PHASING

Take particular care that the CTs are connected to the correct phases. For instance, ensure that the CT on phase 1 is connected to the terminal on the DSE module intended for connection to the CT for phase 1.

Additionally ensure that the voltage sensing for phase 1 is actually connected to generator phase 1. Incorrect connection of the phases as described above results in incorrect power factor (pf) measurements, which in turn results in incorrect kW measurements.

One way to check for this is to make use of a single-phase load. Place the load on each phase in turn, run the generator and ensure the kW value appears in the correct phase. For instance if the load is connected to phase 3, ensure the kW figure appears in phase 3 display and not in the display for phase 1 or 2.

2.7.4 CT CLASS

Ensure the correct CT type is chosen. For instance if the DSE module is providing overcurrent protection, ensure the CT is capable of measuring the overload level you wish to protect against, and at the accuracy level you require.

For instance, this may mean fitting a protection class CT (P10 type) to maintain high accuracy while the CT is measuring overload currents.

Conversely, if the DSE module is using the CT for instrumentation only (current protection is disabled or not fitted to the controller), then measurement class CTs can be used. Again, bear in mind the accuracy you require. The DSE module is accurate to better than 1% of the full-scale current reading. To maintain this accuracy you should fit Class 0.5 or Class 1 CTs.

You should check with your CT manufacturer for further advice on selecting your CTs

2.8 INPUTS

2.8.1 DIGITAL INPUTS

Number	6 configurable digital inputs (10 when Analogue Inputs are configured as digital inputs)
Arrangement	Contact between terminal and ground
Low Level Threshold	3.2 V minimum
High Level Threshold	8.1 V maximum
Maximum Input Voltage	+60 V DC with respect to plant supply negative
Minimum Input Voltage	-24 V DC with respect to plant supply negative
Contact Wetting Current	6 mA typical
Open Circuit Voltage	15 V typical

2.8.2 ANALOGUE INPUTS

2.8.2.1 OIL PRESSURE

Measurement Type	Resistance measurement by measuring voltage across sensor with a fixed current applied
Arrangement	Differential resistance measurement input
Measurement Current	11 mA \pm 10 %
Full Scale	240 Ω
Over Range / Fail	270 Ω
Resolution	0.1 Bar (1-2 PSI)
Accuracy	\pm 2 % of full scale resistance (\pm 4.8 Ω) excluding transducer error
Max Common Mode Voltage	\pm 2 V
Display Range	0 bar to 17.2 bar (0 PSI to 250 PSI) subject to limits of the sensor

2.8.2.2 COOLANT TEMPERATURE

Measurement Type	Resistance measurement by measuring voltage across sensor with a fixed current applied
Arrangement	Differential resistance measurement input
Measurement Current	11 mA \pm 10 %
Full Scale	480 Ω
Over Range / Fail	540 Ω
Resolution	1 $^{\circ}$ C (2 $^{\circ}$ F)
Accuracy	\pm 2 % of full scale resistance (\pm 9.6 Ω) excluding transducer error
Max Common Mode Voltage	\pm 2 V
Display Range	0 $^{\circ}$ C to 250 $^{\circ}$ C (32 $^{\circ}$ F to 482 $^{\circ}$ F) subject to limits of the sensor

2.8.2.3 FUEL LEVEL SENSOR

Measurement Type	Resistance measurement by measuring voltage across sensor with a fixed current applied
Arrangement	Differential resistance measurement input
Measurement Current	11 mA \pm 10 %
Full Scale	480 Ω
Over Range / Fail	540 Ω
Resolution	1 %
Accuracy	+/-2 % of full scale resistance (\pm 9.6 Ω) excluding transducer error
Max Common Mode Voltage	\pm 2 V
Display Range	0 % to 250 % subject to limits of the sensor

2.8.2.4 FLEXIBLE SENSOR

2.8.2.4.1 RESISTIVE CONFIGURATION

Number	2 when <i>Fuel Level Sender</i> is configured as a flexible
Measurement Type	Resistance measurement by measuring voltage across sensor with a fixed current applied
Arrangement	Differential resistance measurement input
Measurement Current	11 mA \pm 10 %
Full Scale	480 Ω
Over Range / Fail	540 Ω
Resolution	1 %
Accuracy	+/-2 % of full scale resistance (\pm 9.6 Ω) excluding transducer error
Max Common Mode Voltage	\pm 2 V
Display Range	0 % to 250 %, 0 $^{\circ}$ C to 250 $^{\circ}$ C (32 $^{\circ}$ F to 482 $^{\circ}$ F) or 0 bar to 17.2 bar (0 PSI to 250 PSI) subject to limits of the sensor and sensor configuration

2.8.2.4.2 0-10V INPUT CONFIGURATION

Number	1 configurable ratiometric input
Full Scale	0 V to 10 V
Resolution	1%
Accuracy	+/-2% of full scale voltage (\pm 0.2 V) excluding transducer error
Max Common Mode Voltage	\pm 2 V
Display Range	0% to 250%, -200 $^{\circ}$ C to 1300 $^{\circ}$ C (-328 $^{\circ}$ F to 2372 $^{\circ}$ F) or 0 bar to 17.2 bar (0 PSI to 250 PSI) subject to limits of the sensor and sensor configuration

2.8.2.4.3 4-20 MA INPUT CONFIGURATION

Number	1 configurable ratiometric input
Full Scale	0 mA to 20 mA
Resolution	1%
Accuracy	+/-2% of full scale resistance (\pm 0.4 mA) excluding transducer error
Max Common Mode Voltage	\pm 2 V
Display Range	00% to 250%, -200 $^{\circ}$ C to 1300 $^{\circ}$ C (-328 $^{\circ}$ F to 2372 $^{\circ}$ F) or 0 bar to 17.2 bar (0 PSI to 250 PSI) subject to limits of the sensor and sensor configuration

2.8.3 CHARGE FAIL INPUT

Minimum Voltage	0 V
Maximum Voltage	35 V (plant supply)
Resolution	0.2 V
Accuracy	±1 % of max measured voltage
Excitation	Active circuit constant power output
Output Power	2.5 W nominal at 12 V and 24 V
Current At 12V	210 mA
Current At 24V	105 mA

The charge fail input is actually a combined input and output. Whenever the generator is required to run, the terminal provides excitation current to the charge alternator field winding.

When the charge alternator is correctly charging the battery, the voltage of the terminal is close to the plant battery supply voltage. In a failed charge situation, the voltage of this terminal is pulled down to a low voltage. It is this drop in voltage that triggers the *Charge Failure* alarm. The level at which this operates and whether this triggers a warning or shutdown alarm is configurable using the DSE Configuration Suite Software.

2.8.4 MAGNETIC PICKUP

▲ NOTE: DSE can supply a suitable magnetic pickup device, available in two body thread lengths:
DSE Part number 020-012 - Magnetic Pickup probe 5/8 UNF 2 1/2" thread length
DSE Part number 020-013 - Magnetic Pickup probe 5/8 UNF 4" thread length

Type	Differential input
Minimum Voltage	0.5 V RMS
Max Common Mode Voltage	±2 V
Maximum Voltage	Clamped to ±70 V by transient suppressers, dissipation not to exceed 1 W.
Maximum Frequency	10,000 Hz
Resolution	6.25 RPM
Accuracy	±25 RPM
Flywheel Teeth	10 to 500

Magnetic Pickup devices can often be 'shared' between two or more devices. For example, one device can often supply the signal to both the DSE module and the engine governor. The possibility of this depends upon the amount of current that the magnetic pickup can supply.

2.9 OUTPUTS

2.9.1 DC OUTPUTS A & B (FUEL & START)

Type	Normally used as Fuel & Start outputs. Fully configurable for other purposes if the module is configured to control an electronic engine.
Rating	10 A resistive for 10 secs, 5 A resistive continuous at 35 V

2.9.2 CONFIGURABLE DC OUTPUTS C, D, E & F

Type	Fully configurable, supplied from DC supply terminal 2.
Rating	2 A resistive continuous at 35 V

2.10 COMMUNICATION PORTS

USB Port	USB 2.0 Device for connection to PC running DSE configuration suite only. Max distance 6m (18 yards)
CAN Port	<div style="border: 1px solid black; padding: 5px; margin-bottom: 5px;"> <p>▲NOTE: For additional length, the DSE124 CAN Extender is available. For more information, refer to DSE Publication: 057-116 DSE124 Operator Manual</p> </div> <p>Engine CAN Port Standard implementation of 'Slow mode', up to 250 K bits/s Non-Isolated. Internal Termination provided (120 Ω) Max distance 40 m (133 feet)</p>

2.10.1 CAN INTERFACE

▲NOTE: For further details on connection to electronic engines, refer to DSE Publication: 057-004 Electronic Engines And DSE Wiring

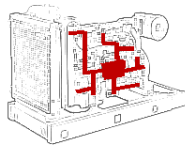

Modules are fitted with the CAN interface as standard and are capable of receiving engine data from engine CAN controllers compliant with the CAN standard.

CAN enabled engine controllers monitor the engine's operating parameters such as engine speed, oil pressure, engine temperature (among others) in order to closely monitor and control the engine. The industry standard communications interface (CAN) transports data gathered by the engine controller interface. This allows generator controllers to access these engine parameters with no physical connection to the sensor device.

2.10.2 USB CONNECTION

NOTE: The DC supply must be connected to the module for configuration by PC.

NOTE: For further details of module configuration, refer to DSE Publication: *057-223 DSE60xx MKII Configuration Software Manual*.

The USB port is provided to give a simple means of connection between a PC and the controller. Using the DSE Configuration Suite Software, the operator is then able to control the module, starting or stopping the generator, selecting operating modes, etc.

Additionally, the various operating parameters (such as output volts, oil pressure, etc.) of the remote generator are available to be viewed or changed.

To connect a module to a PC by USB, the following items are required:

- DSE6010 MKII & DSE6020 MKII Controller



- DSE Configuration Suite PC Software (Supplied on configuration suite software CD or available from www.deepseapl.com).



- USB cable Type A to Type B. (This is the same cable as often used between a PC and a USB printer)



DSE can supply this cable if required :
PC Configuration interface lead (USB type A – type B)
DSE Part No 016-125

2.11 ADDING AN EXTERNAL SOUNDER

Should an external alarm or indicator be required, this can be achieved by using the DSE Configuration Suite PC software to configure an auxiliary output for *Audible Alarm*, and by configuring an auxiliary input for *Alarm Mute* (if required).

The audible alarm output activates and de-activates at the same time as the module's internal sounder. The Alarm mute input and internal **Lamp Test / Alarm Mute**  button activate 'in parallel' with each other. Either signal mutes both the internal sounder and audible alarm output.

Example of configuration to achieve external sounder with external alarm mute button:

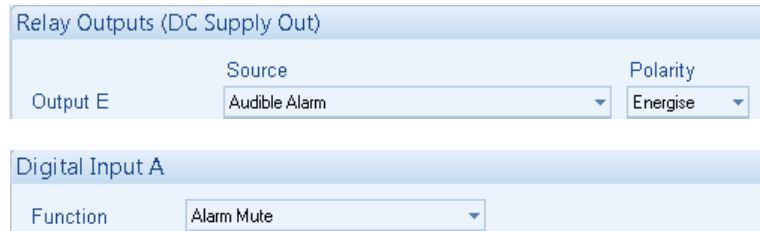

The screenshot shows two configuration panels. The top panel, titled 'Relay Outputs (DC Supply Out)', has a table with three columns: 'Output E', 'Source', and 'Polarity'. The 'Source' dropdown is set to 'Audible Alarm' and the 'Polarity' dropdown is set to 'Energise'. The bottom panel, titled 'Digital Input A', has a table with two columns: 'Function' and a dropdown menu set to 'Alarm Mute'.

2.12 ACCUMULATED INSTRUMENTATION

NOTE: When an accumulated instrumentation value exceeds the maximum number as listed below, the value is reset and begins counting from zero again.

Engine Hours Run	Maximum 99999 hrs 59 minutes (Approximately 11yrs 4 months)
Accumulated Power	999999 kWh / kVAh / kVAh

The number of logged *Engine Hours* and *Number of Starts* can be set/reset using the DSE Configuration Suite PC software. Depending upon module configuration, this may have been PIN number locked by your generator supplier

2.13 DIMENSIONS AND MOUNTING

2.13.1 DIMENSIONS

216 mm x 158 mm x 43 mm
(8.5" x 6.2" x 1.5")

2.13.2 PANEL CUTOUT

184 mm x 137 mm
(7.2" x 5.3")

2.13.3 WEIGHT

0.45 kg
(1.00 lb)

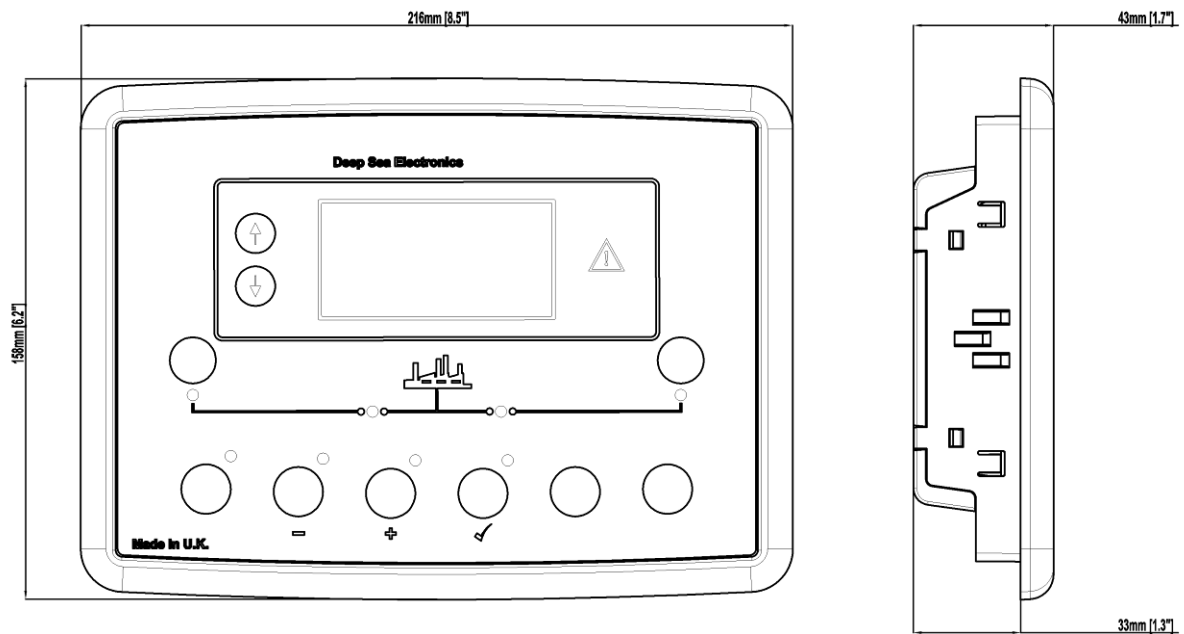

2.13.4 FIXING CLIPS

NOTE: In conditions of excessive vibration, mount the module on suitable anti-vibration mountings.

The module is held into the panel fascia using the supplied fixing clips.

- Withdraw the fixing clip screw (turn anticlockwise) until only the pointed end is protruding from the clip.
- Insert the three 'prongs' of the fixing clip into the slots in the side of the module case.
- Pull the fixing clip backwards (towards the back of the module) ensuring all three prongs of the clip are inside their allotted slots.
- Turn the fixing clip screws clockwise until they make contact with the panel fascia.
- Turn the screws a little more to secure the module into the panel fascia. Care should be taken not to over tighten the fixing clip screws.

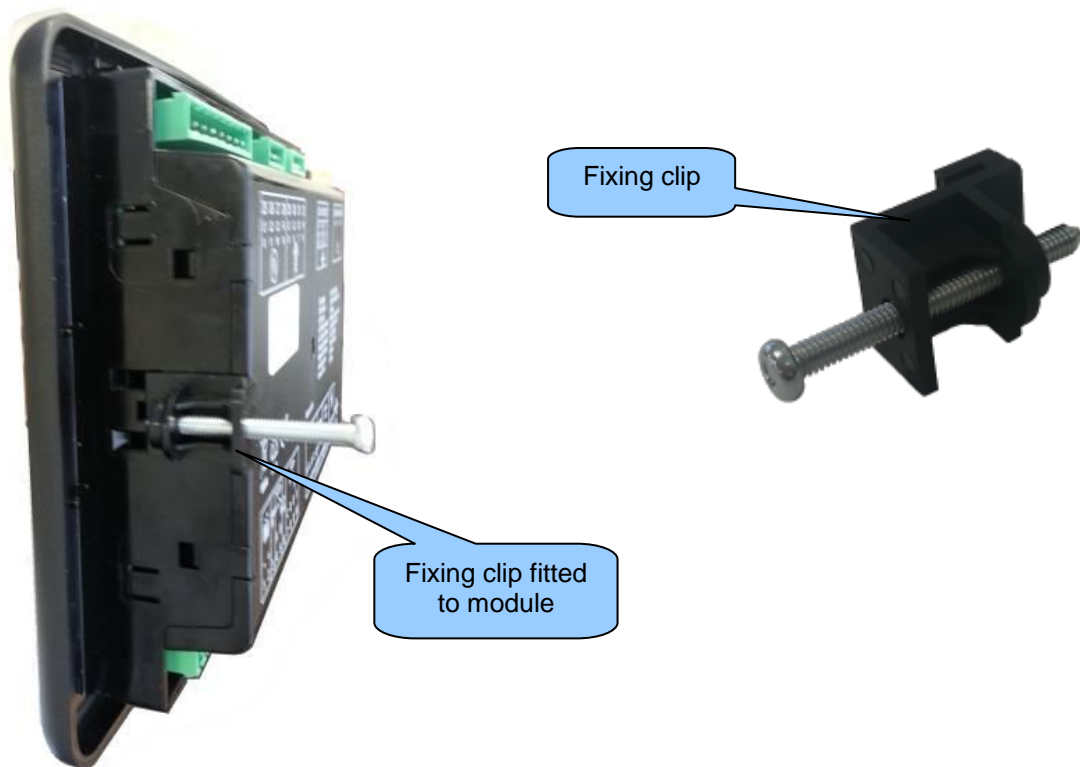

2.13.5 SILICON SEALING GASKET

NOTE: For purchasing an additional silicon gasket from DSE, please see the section entitled **Maintenance, Spares, Repair and Servicing** elsewhere in this document.

The optional silicon gasket provides improved sealing between module and the panel fascia. The gasket is fitted to the module before installation into the panel fascia. Take care to ensure the gasket is correctly fitted to the module to maintain the integrity of the seal.

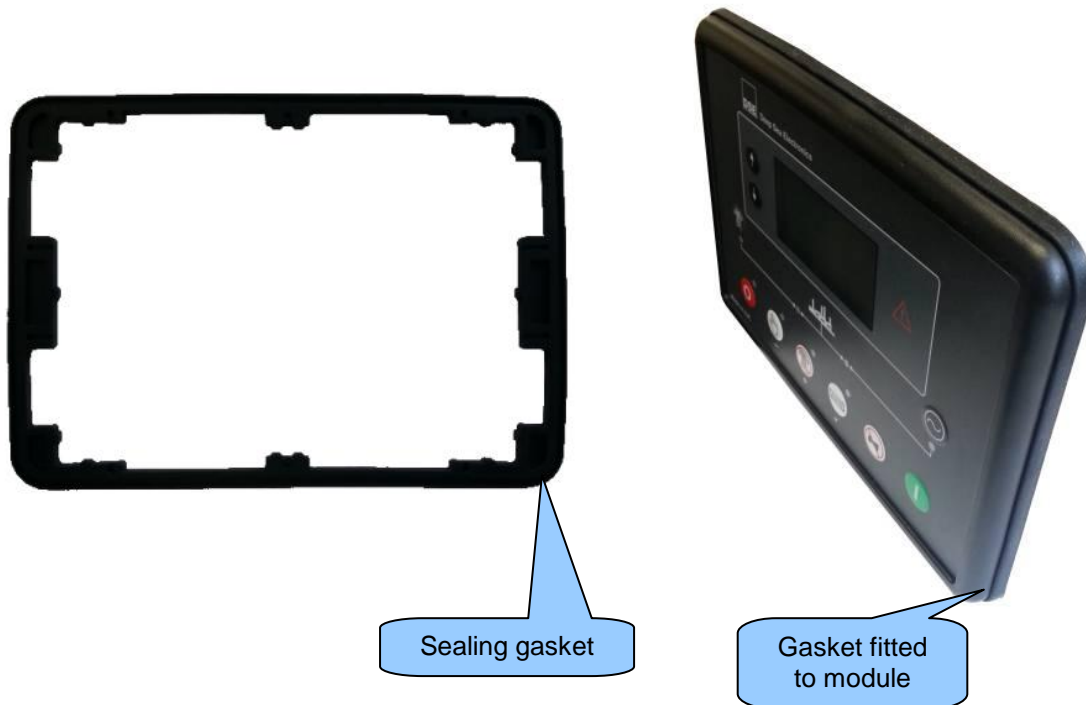

2.13.6 APPLICABLE STANDARDS

BS 4884-1	This document conforms to BS4884-1 1992 Specification for presentation of essential information.
BS 4884-2	This document conforms to BS4884-2 1993 Guide to content
BS 4884-3	This document conforms to BS4884-3 1993 Guide to presentation
BS EN 60068-2-1 (Minimum temperature)	-30 °C (-22 °F)
BS EN 60068-2-2 (Maximum temperature)	+70 °C (158 °F)
BS EN 60950	Safety of information technology equipment, including electrical business equipment
BS EN 61000-6-2	EMC Generic Immunity Standard (Industrial)
BS EN 61000-6-4	EMC Generic Emission Standard (Industrial)
BS EN 60529 (Degrees of protection provided by enclosures)	IP65 (front of module when installed into the control panel with the optional sealing gasket) IP42 (front of module when installed into the control panel WITHOUT being sealed to the panel)
UL508 NEMA rating (Approximate)	12 (Front of module when installed into the control panel with the optional sealing gasket). 2 (Front of module when installed into the control panel WITHOUT being sealed to the panel)
IEEE C37.2 (Standard Electrical Power System Device Function Numbers and Contact Designations)	<p>Under the scope of IEEE 37.2, <i>function numbers can also be used to represent functions in microprocessor devices and software programs.</i> The controller is device number 11L-8000 (Multifunction device protecting Line (generator) –module).</p> <p>As the module is configurable by the generator OEM, the functions covered by the module vary. Under the module's factory configuration, the device numbers included within the module are :</p> <ul style="list-style-type: none"> 2 – Time Delay Starting Or Closing Relay 3 – Checking Or Interlocking Relay 5 – Stopping Device 6 – Starting Circuit Breaker 8 – Control Power Disconnecting Device 10 – Unit Sequence Switch 11 – Multifunction Device 12 – Overspeed Device 14 – Underspeed Device 26 – Apparatus Thermal Device 27AC – AC Undervoltage Relay 27DC – DC Undervoltage Relay 29 – Isolating Contactor Or Switch 30 – Annunciator Relay 31 – Separate Excitation Device 42 – Running Circuit Breaker

Continued overleaf...

Specification

IEEE C37.2 (Standard Electrical Power System Device Function Numbers and Contact Designations)	Continued... 50 – Instantaneous Overcurrent Relay 52 – AC Circuit Breaker 53 – Exciter Or DC Generator Relay 54 – Turning Gear Engaging Device 59AC – AC Overvoltage Relay 59DC – DC Overvoltage Relay 62 – Time Delay Stopping Or Opening Relay 63 – Pressure Switch 71 – Level Switch 74 – Alarm Relay 81 – Frequency Relay 83 – Automatic Selective Control Or Transfer Relay 86 – Lockout Relay
---	--

In line with our policy of continual development, Deep Sea Electronics, reserve the right to change specification without notice.

2.13.7 ENCLOSURE CLASSIFICATIONS

2.13.7.1 IP CLASSIFICATIONS

The modules specification under **BS EN 60529** Degrees of protection provided by enclosures

IP65 (Front of module when module is installed into the control panel with the optional sealing gasket).

IP42 (front of module when module is installed into the control panel WITHOUT being sealed to the panel)

First Digit	Second Digit
Protection against contact and ingress of solid objects	Protection against ingress of water
0 No protection	0 No protection
1 Protected against ingress solid objects with a diameter of more than 50 mm. No protection against deliberate access, e.g. with a hand, but large surfaces of the body are prevented from approach.	1 Protection against dripping water falling vertically. No harmful effect must be produced (vertically falling drops).
2 Protected against penetration by solid objects with a diameter of more than 12 mm. Fingers or similar objects prevented from approach.	2 Protection against dripping water falling vertically. There must be no harmful effect when the equipment (enclosure) is tilted at an angle up to 15° from its normal position (drops falling at an angle).
3 Protected against ingress of solid objects with a diameter of more than 2.5 mm. Tools, wires etc. with a thickness of more than 2.5 mm are prevented from approach.	3 Protection against water falling at any angle up to 60° from the vertical. There must be no harmful effect (spray water).
4 Protected against ingress of solid objects with a diameter of more than 1 mm. Tools, wires etc. with a thickness of more than 1 mm are prevented from approach.	4 Protection against water splashed against the equipment (enclosure) from any direction. There must be no harmful effect (splashing water).
5 Protected against harmful dust deposits. Ingress of dust is not totally prevented but the dust must not enter in sufficient quantity to interfere with satisfactory operation of the equipment. Complete protection against contact.	5 Protection against water projected from a nozzle against the equipment (enclosure) from any direction. There must be no harmful effect (water jet).
6 Protection against ingress of dust (dust tight). Complete protection against contact.	6 Protection against heavy seas or powerful water jets. Water must not enter the equipment (enclosure) in harmful quantities (splashing over).

2.13.7.2 NEMA CLASSIFICATIONS

THE MODULES NEMA RATING (APPROXIMATE)

12 (Front of module when module is installed into the control panel with the optional sealing gasket).

2 (front of module when module is installed into the control panel WITHOUT being sealed to the panel)

▲ NOTE: There is no direct equivalence between IP / NEMA ratings. IP figures shown are approximate only.

1 IP30	Provides a degree of protection against contact with the enclosure equipment and against a limited amount of falling dirt.
2 IP31	Provides a degree of protection against limited amounts of falling water and dirt.
3 IP64	Provides a degree of protection against windblown dust, rain and sleet; undamaged by the formation of ice on the enclosure.
3R IP32	Provides a degree of protection against rain and sleet; undamaged by the formation of ice on the enclosure.
4 (X) IP66	Provides a degree of protection against splashing water, windblown dust and rain, hose directed water; undamaged by the formation of ice on the enclosure. (Resist corrosion).
12/12K IP65	Provides a degree of protection against dust, falling dirt and dripping non corrosive liquids.
13 IP65	Provides a degree of protection against dust and spraying of water, oil and non corrosive coolants.

3 INSTALLATION

The module is designed to be mounted on the panel fascia. For dimension and mounting details, see the section entitled *Specification, Dimension and mounting* elsewhere in this document.

3.1 TERMINAL DESCRIPTION

NOTE: Availability of some terminals depends upon module version. Full details are given in the section entitled *Terminal Description* elsewhere in this manual.



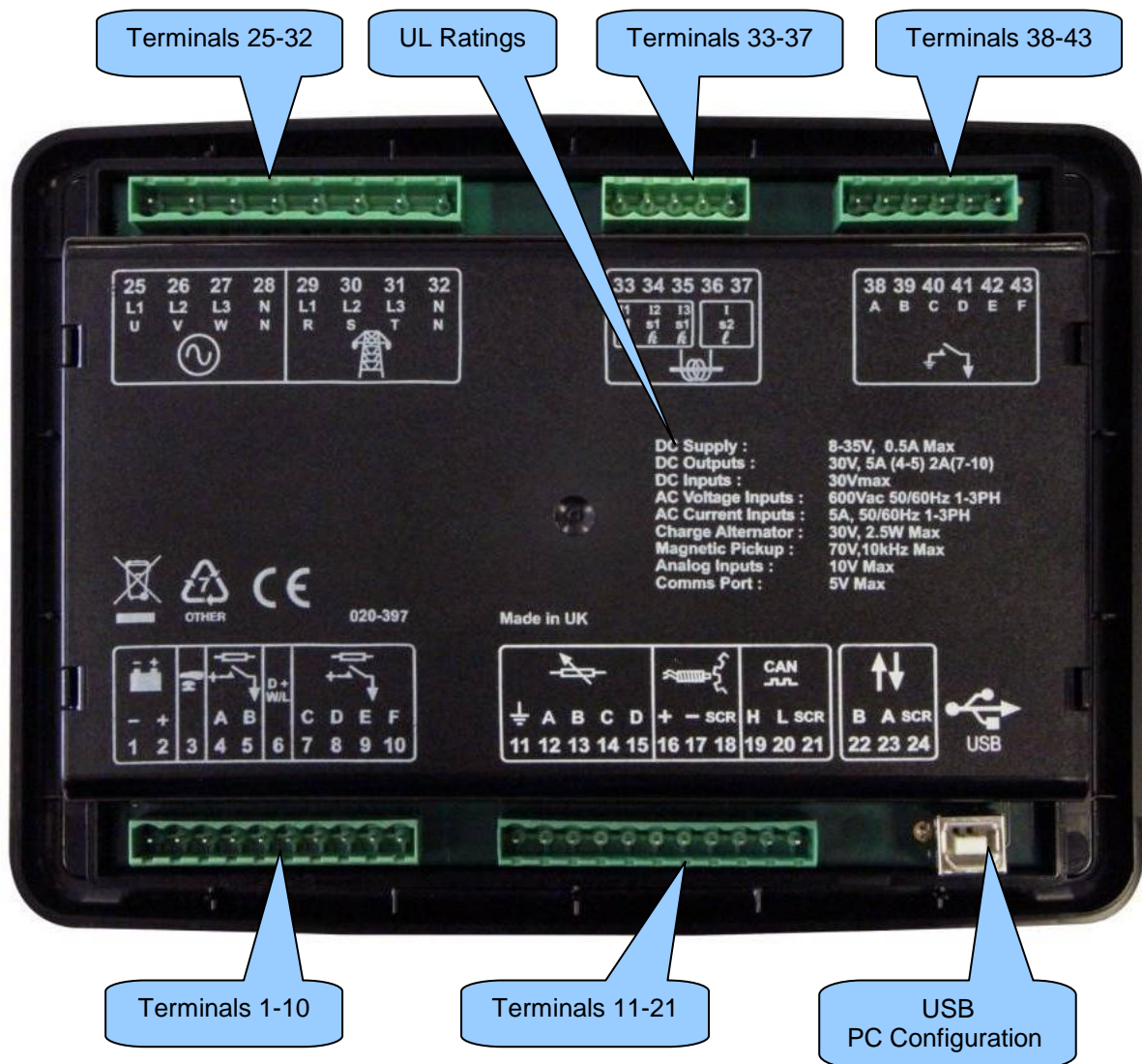

To aid user connection, icons are used on the rear of the module to help identify terminal functions. An example of this is shown below.



3.1.1 DC SUPPLY, ESTOP INPUT, DC OUTPUTS & CHARGE FAIL INPUT

NOTE: When the module is configured for operation with an electronic engine, FUEL and START output requirements may be different. For further details on connection to electronic engines, refer to DSE Publication: *057-004 Electronic Engines And DSE Wiring*

NOTE: For further details of module configuration, refer to DSE Publication: *057-223 DSE6010 MKII & 6020 MKII Configuration Software Manual.*

	Pin No	Description	Cable Size	Notes
	1	DC Plant Supply Input (Negative)	2.5 mm ² AWG 13	
	2	DC Plant Supply Input (Positive)	2.5 mm ² AWG 13	Supplies the module and DC Outputs A, B, C, D, E & F
	3	Emergency Stop Input	2.5 mm ² AWG 13	Plant Supply Positive. Also supplies DC Outputs A & B. (Recommended Maximum Fuse 20A)
	4	DC Output A (FUEL)	2.5 mm ² AWG 13	Plant Supply Positive from terminal 2. 10A for 10secs, 5A resistive continuous. Fixed as FUEL relay if electronic engine is not configured.
	5	DC Output B (START)	2.5 mm ² AWG 13	Plant Supply Positive from terminal 2. 10A for 10secs, 5A resistive continuous. Fixed as START relay if electronic engine is not configured.
D + W/L	6	Charge Fail / Excite	2.5 mm ² AWG 13	Do not connect to ground (battery negative). If charge alternator is not fitted, leave this terminal disconnected.
	7	DC Output C	1.0 mm ² AWG 18	Plant Supply Positive from terminal 2. 2 Amp rated.
	8	DC Output D	1.0 mm ² AWG 18	Plant Supply Positive from terminal 2. 2 Amp rated.
	9	DC Output E	1.0 mm ² AWG 18	Plant Supply Positive from terminal 2. 2 Amp rated.
	10	DC Output F	1.0 mm ² AWG 18	Plant Supply Positive from terminal 2. 2 Amp rated.

3.1.2 ANALOGUE SENSORS, MPU & CAN



NOTE: It is VERY important that terminal 11 (sensor common) is soundly connected to an earth point on the ENGINE BLOCK, not within the control panel, and must be a sound electrical connection to the sensor bodies. This connection MUST NOT be used to provide an earth connection for other terminals or devices. The simplest way to achieve this is to run a SEPARATE earth connection from the system earth star point, to terminal 11 directly, and not use this earth for other connections.

NOTE: If you use PTFE insulating tape on the sensor thread when using earth return sensors, ensure you do not insulate the entire thread, as this prevents the sensor body from being earthed via the engine block.

NOTE: For further details on connection to electronic engines, refer to DSE Publication: *057-004 Electronic Engines And DSE Wiring*

NOTE: Screened 120 Ω impedance cable specified for use with CAN must be used for the CAN link.
DSE stock and supply Belden cable 9841 which is a high quality 120 Ω impedance cable suitable for CAN use (DSE part number 016-030)



NOTE: For further details of module configuration, refer to DSE Publication: *057-223 DSE6010 MKII & 6020 MKII Configuration Software Manual.*

	Pin No	Description	Cable Size	Notes
	11	Sensor Common Return	0.5 mm ² AWG 20	Return Feed For Sensors
	12	Oil Pressure Input	0.5 mm ² AWG 20	Connect To Oil Pressure Sensor
	13	Coolant Temperature Input	0.5mm ² AWG 20	Connect To Coolant Temperature Sensor
	14	Fuel Level Input	0.5 mm ² AWG 20	Connect To Fuel Level Sensor
	15	Flexible Sensor Input	0.5 mm ² AWG 20	Connect To Additional Sensor (User Configurable)
	18	Magnetic Pickup Positive	0.5 mm ² AWG 20	Connect To Magnetic Pickup Device
	19	Magnetic Pickup Negative	0.5 mm ² AWG 20	Connect To Magnetic Pickup Device
	20	Magnetic Pickup Screen	Shield	Connect To Ground At One End Only
	19	CAN Port H	0.5 mm ² AWG 20	Use Only 120 Ω CAN Approved Cable
	20	CAN Port L	0.5 mm ² AWG 20	Use Only 120 Ω CAN Approved Cable
	21	CAN Port Screen	Shield	Use Only 120 Ω CAN Approved Cable

3.1.3 GENERATOR / MAINS VOLTAGE & FREQUENCY SENSING

 **NOTE: Terminals 29 to 32 not fitted to DSE6010 MKII**

 **NOTE: The above table describes connections to a three phase, four wire alternator. For alternative wiring topologies, please see the Alternate Topology Wiring Diagrams section of this manual.**

	Pin No	Description	Cable Size	Notes
	25	Generator L1 (U) Voltage Monitoring	1.0 mm ² AWG 18	Connect to generator L1 (U) output (AC) (Recommend 2A fuse)
	26	Generator L2 (V) Voltage Monitoring	1.0 mm ² AWG 18	Connect to generator L2 (V) output (AC) (Recommend 2A fuse)
	27	Generator L3 (W) Voltage Monitoring	1.0 mm ² AWG 18	Connect to generator L3 (W) output (AC) (Recommend 2A fuse)
	28	Generator Neutral (N) Input	1.0 mm ² AWG 18	Connect to generator Neutral terminal (AC)
	29	Mains L1 (R) Voltage Monitoring	1.0 mm ² AWG 18	Connect to Mains L1 (R) output (AC) (Recommend 2A fuse)
	30	Mains L2 (S) Voltage Monitoring	1.0 mm ² AWG 18	Connect to Mains L2 (S) output (AC) (Recommend 2A fuse)
	31	Mains L3 (T) Voltage Monitoring	1.0 mm ² AWG 18	Connect to Mains L3 (T) output (AC) (Recommend 2A fuse)
	32	Mains Neutral (N) Input	1.0 mm ² AWG 18	Connect to Mains Neutral terminal (AC)

3.1.4 CURRENT TRANSFORMERS

 **WARNING!:** Do not disconnect this plug when the CTs are carrying current. Disconnection open circuits the secondary of the C.T.'s and dangerous voltages may then develop. Always ensure the CTs are not carrying current and the CTs are short circuit connected before making or breaking connections to the module.

 **NOTE:** The module has a burden of 0.5VA on the CT. Ensure the CT is rated for the burden of the controller, the cable length being used and any other equipment sharing the CT. If in doubt, consult your CT supplier.

	Pin No	Description	Cable Size	Notes
	33	CT Secondary for L1	2.5 mm ² AWG 13	Connect to s1 secondary of L1 monitoring CT
	34	CT Secondary for L2	2.5 mm ² AWG 13	Connect to s1 secondary of L2 monitoring CT
	35	CT Secondary for L3	2.5 mm ² AWG 13	Connect to s1 secondary of L3 monitoring CT
	36	CT Common	2.5 mm ² AWG 13	Connect to s2 secondary of L1, L2 & L3 monitoring CTs and ground
	37			

3.1.4.1 CT CONNECTIONS

p1, κ or K is the primary of the CT that 'points' towards the GENERATOR

p2, ℓ or L is the primary of the CT that 'points' towards the Load

s1 is the secondary of the CT that connects to the DSE Module's input for the CT measuring

s2 is the secondary of the CT that should be commoned with the s2 connections of all the other CTs and connected to the CT common terminal of the module.

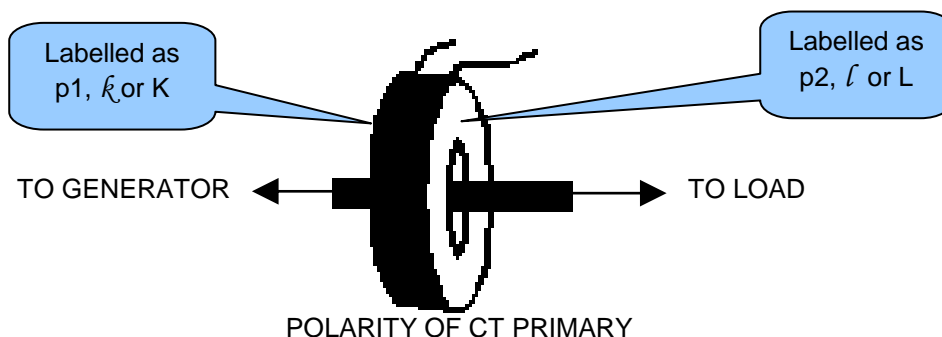

3.1.5 CONFIGURABLE DIGITAL INPUTS

NOTE: For further details of module configuration, refer to DSE Publication: 057-223 *DSE6010 MKII & 6020 MKII Configuration Software Manual*.



	Pin No	Description	Cable Size	Notes
	38	Configurable Digital Input A	0.5 mm ² AWG 20	Switch To Negative
	39	Configurable Digital Input B	0.5 mm ² AWG 20	Switch To Negative
	40	Configurable Digital Input C	0.5 mm ² AWG 20	Switch To Negative
	41	Configurable Digital Input D	0.5 mm ² AWG 20	Switch To Negative
	42	Configurable Digital Input E	0.5 mm ² AWG 20	Switch To Negative
	43	Configurable Digital Input F	0.5 mm ² AWG 20	Switch To Negative

3.1.6 PC CONFIGURATION INTERFACE CONNECTOR

NOTE: The USB connection cable between the PC and the module must not be extended beyond 5m (yards). For distances over 5m, it is possible to use a third party USB extender. Typically, they extend USB up to 50m. The supply and support of this type of equipment is outside the scope of Deep Sea Electronics PLC.

CAUTION! Care must be taken not to overload the PCs USB system by connecting more than the recommended number of USB devices to the PC. For further information, consult your PC supplier.

NOTE: For further details of module configuration, refer to DSE Publication: *057-223 DSE6010 MKII & 6020 MKII Configuration Software Manual*.

	Description	Cable Size	Notes
	Socket for connection to PC with DSE Configuration Suite Software	0.5 mm ² AWG 20	This is a standard USB type A to type B connector. 

3.2 TYPICAL WIRING DIAGRAM

As every system has different requirements, these diagrams show only a TYPICAL system and do not intend to show a complete system.

Genset manufacturers and panel builders may use these diagrams as a starting point; however, you are referred to the completed system diagram provided by your system manufacturer for complete wiring detail.

Further wiring suggestions are available in the following DSE publications, available at www.deepseapl.com to website members.

DSE Part	Description
056-022	Breaker Control (Training guide)
057-004	Electronic Engines and DSE Wiring

3.2.1 DSE6010 MKII TYPICAL WIRING DIAGRAM (3 PHASE 4 WIRE)

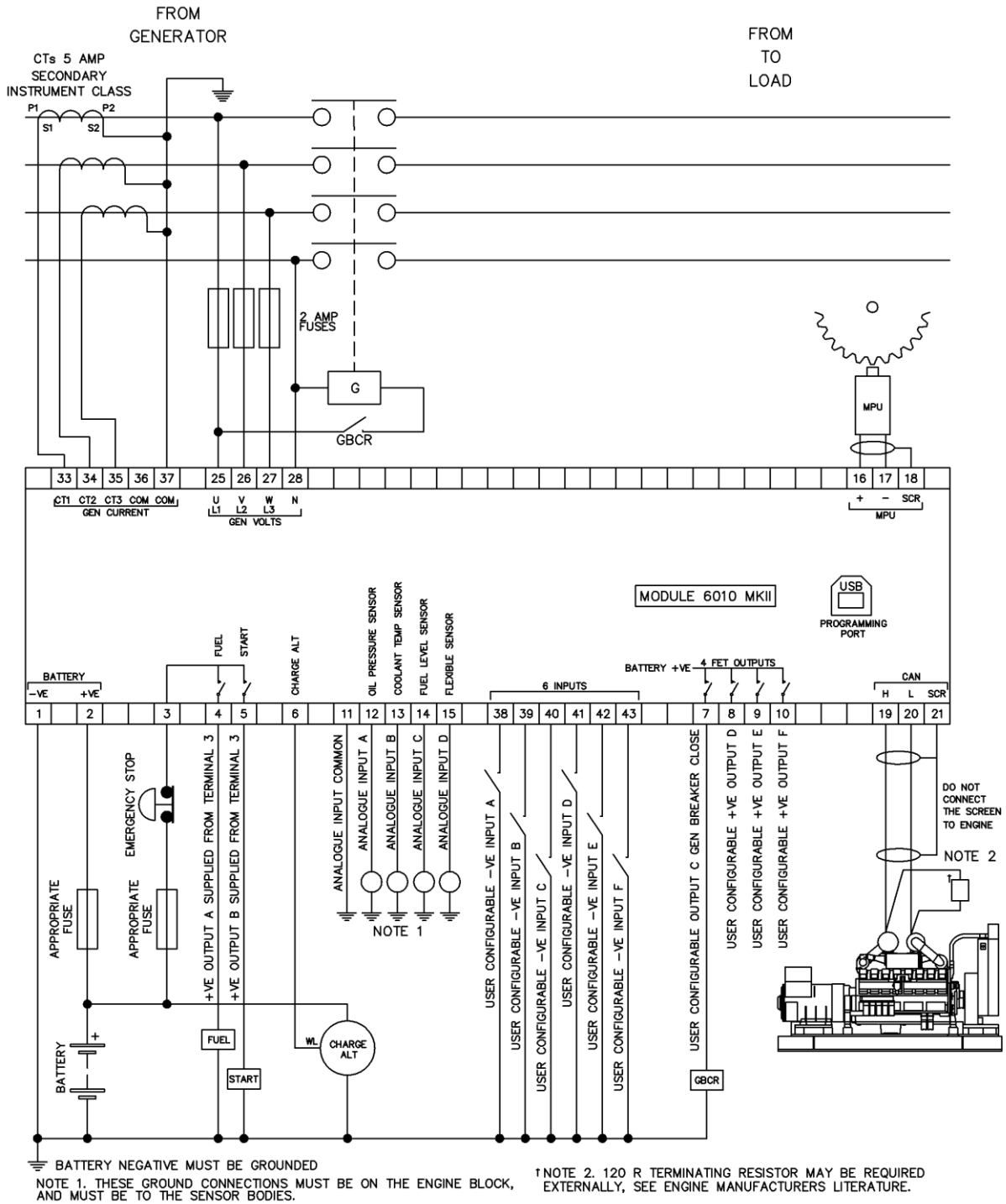

3.2.2 DSE6020 MKII TYPICAL WIRING DIAGRAM (3 PHASE 4 WIRE)

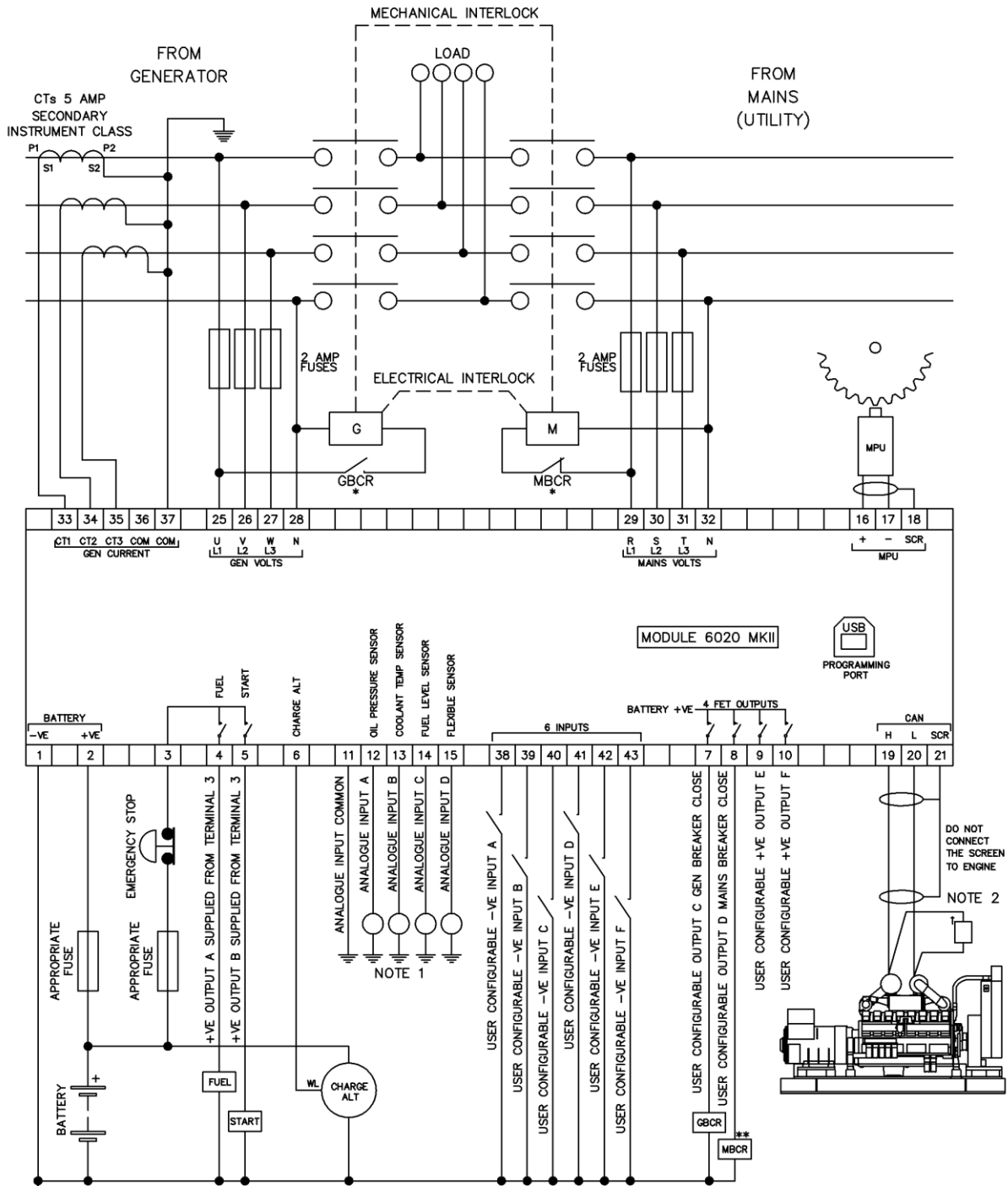

BATTERY NEGATIVE MUST BE GROUND

NOTE 1. THESE GROUND CONNECTIONS MUST BE ON THE ENGINE BLOCK, AND MUST BE TO THE SENSOR BODIES.

*NOTE 3. IT IS RECOMMENDED THAT THE GENERATOR AND MAINS SWITCHING DEVICES ARE MECHANICALLY AND ELECTRICALLY INTERLOCKED.

†NOTE 2. 120 R TERMINATING RESISTOR MAY BE REQUIRED EXTERNALLY, SEE ENGINE MANUFACTURERS LITERATURE.

**NOTE 4. MAINS BREAKER CLOSED OUTPUT SHOULD BE CONFIGURED FOR DE-ENERGISE CLOSE MAINS, AND USE THE NORMALLY CLOSED CONTACTS OF MBCR

3.3 ALTERNATE TOPOLOGY WIRING DIAGRAMS

3.3.1 GENERATOR

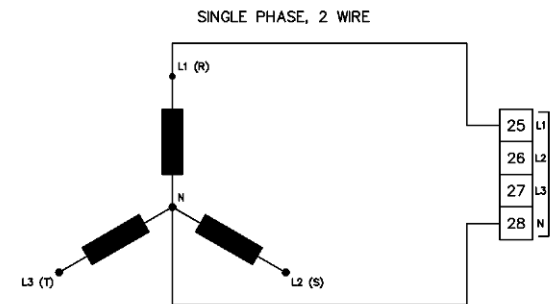
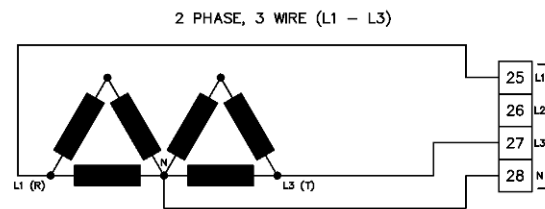
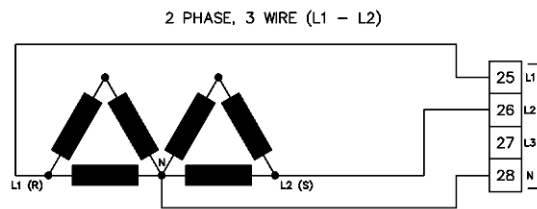
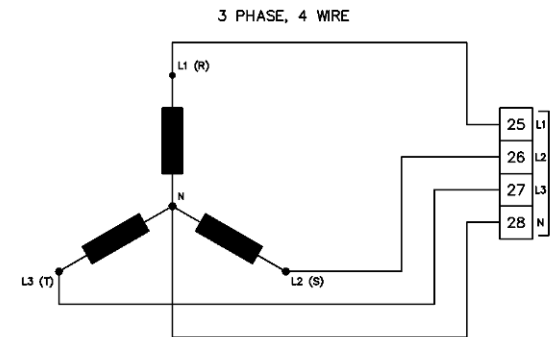
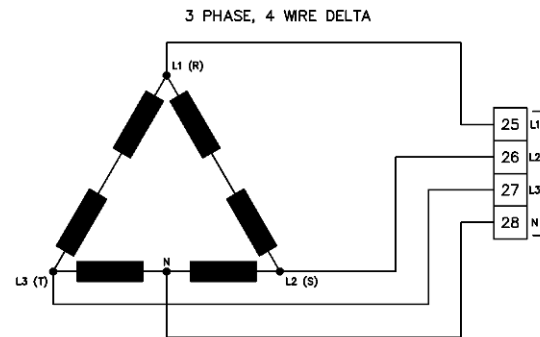
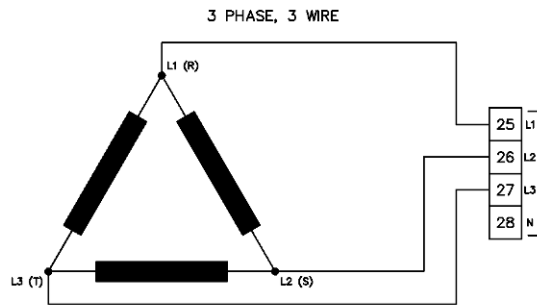

Installation

3.3.2 MAINS (6020 MKII ONLY)

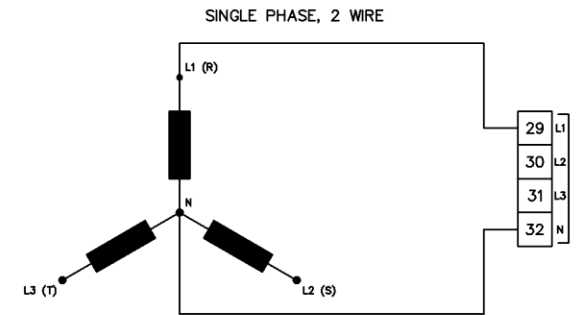
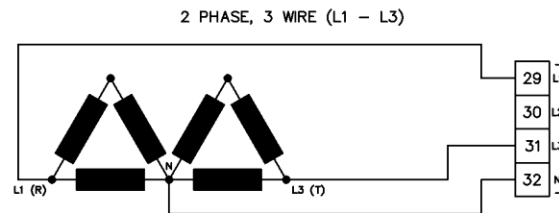
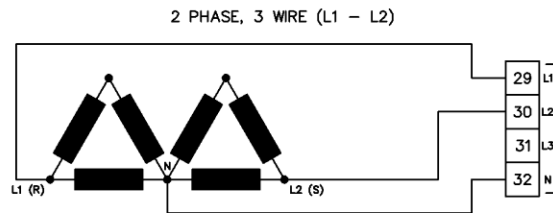
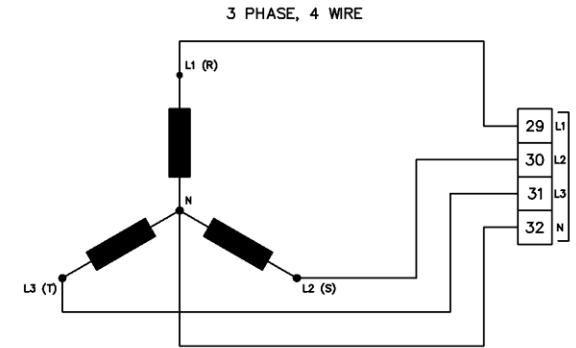
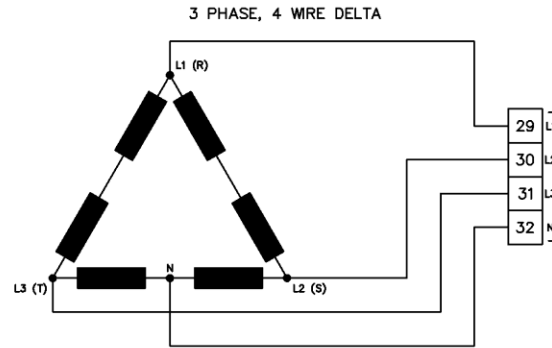
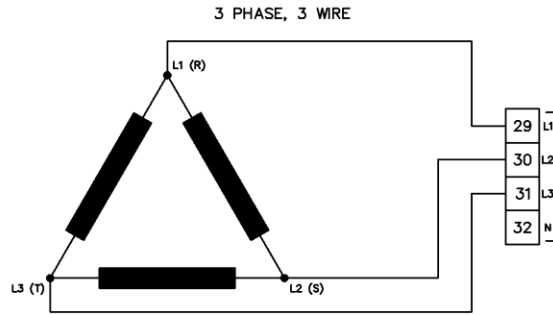

3.4 EARTH SYSTEMS

3.4.1 NEGATIVE EARTH

The typical wiring diagrams located within this document show connections for a negative earth system (the battery negative connects to Earth)

3.4.2 POSITIVE EARTH

When using a DSE module with a Positive Earth System (the battery positive connects to Earth), the following points must be followed:

- Follow the typical wiring diagram as normal for all sections EXCEPT the earth points
- All points shown as Earth on the typical wiring diagram should connect to BATTERY NEGATIVE (not earth).

3.4.3 FLOATING EARTH

Where neither the battery positive nor battery negative terminals are connected to earth the following points must to be followed

- Follow the typical wiring diagram as normal for all sections EXCEPT the earth points
- All points shown as Earth on the typical wiring diagram should connect to BATTERY NEGATIVE (not earth).





4 DESCRIPTION OF CONTROLS



CAUTION: The module may instruct an engine start event due to external influences. Therefore, it is possible for the engine to start at any time without warning. Prior to performing any maintenance on the system, it is recommended that steps are taken to remove the battery and isolate supplies.



NOTE: The following descriptions detail the sequences followed by a module containing the standard 'factory configuration'. Always refer to your configuration source for the exact sequences and timers observed by any particular module in the field.

Control of the module is via push buttons mounted on the front of the module with *Stop/Reset Mode* , *Manual Mode* , *Test Mode*  (DSE6020 MKII Only), *Auto Mode*  and *Start*  functions. For normal operation, these are the only controls which need to be operated. Details of their operation are provided later in this document.



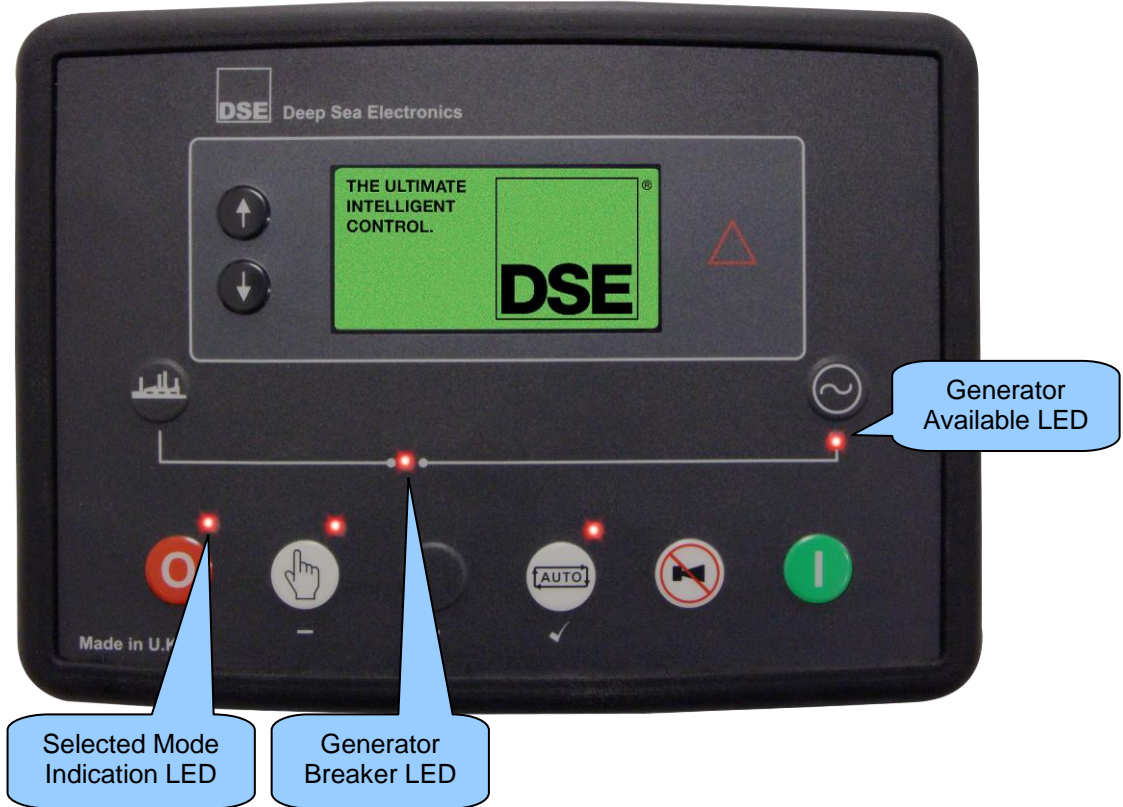
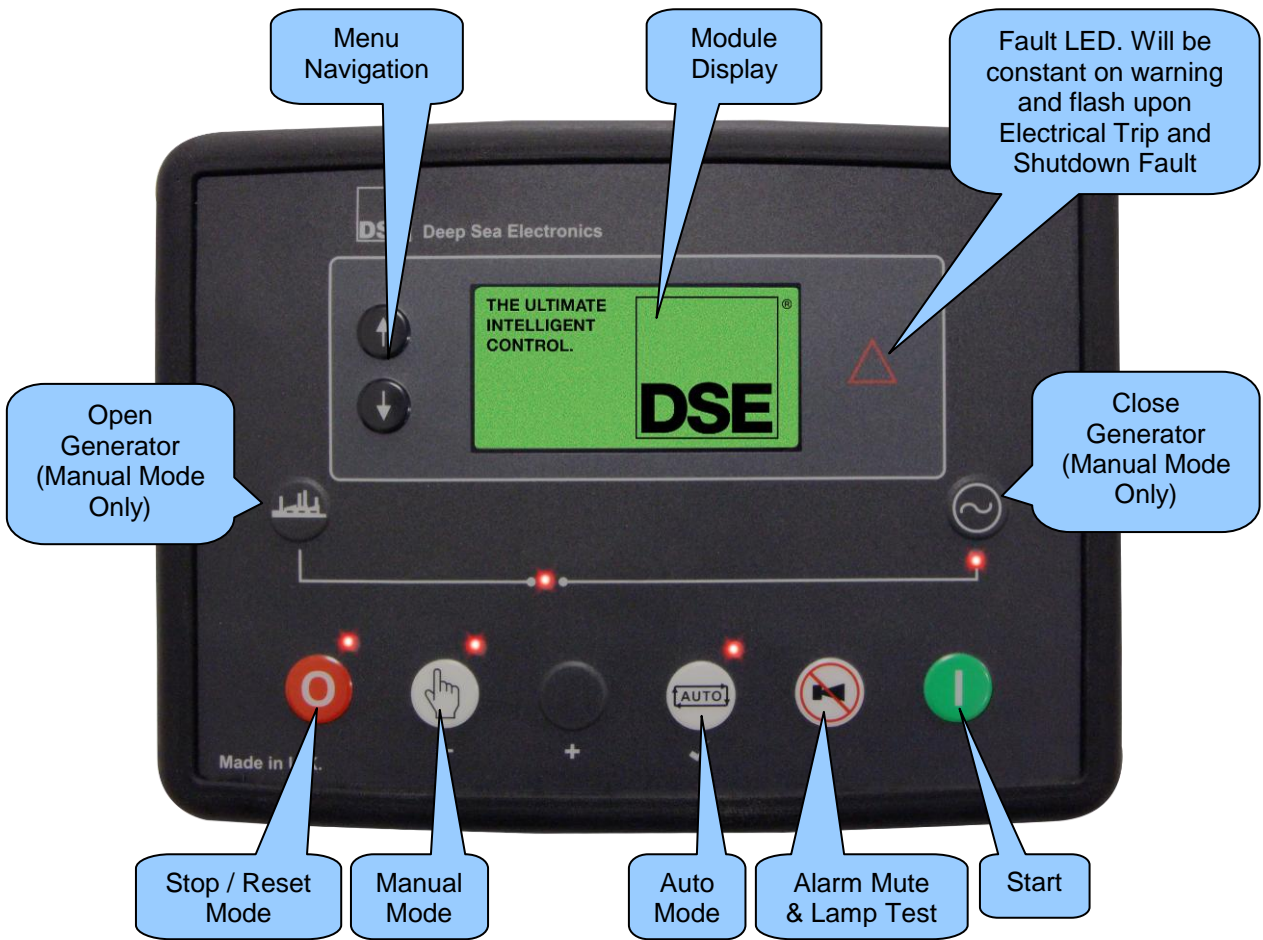



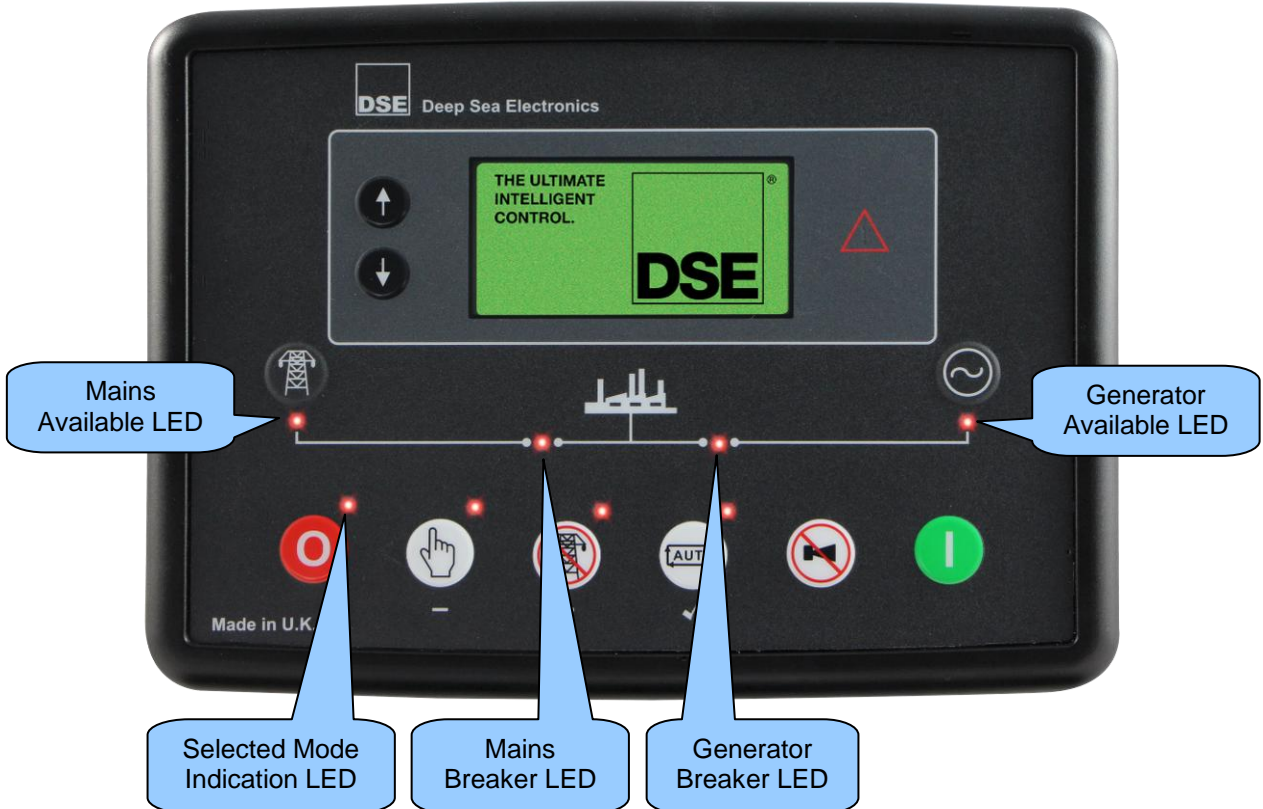
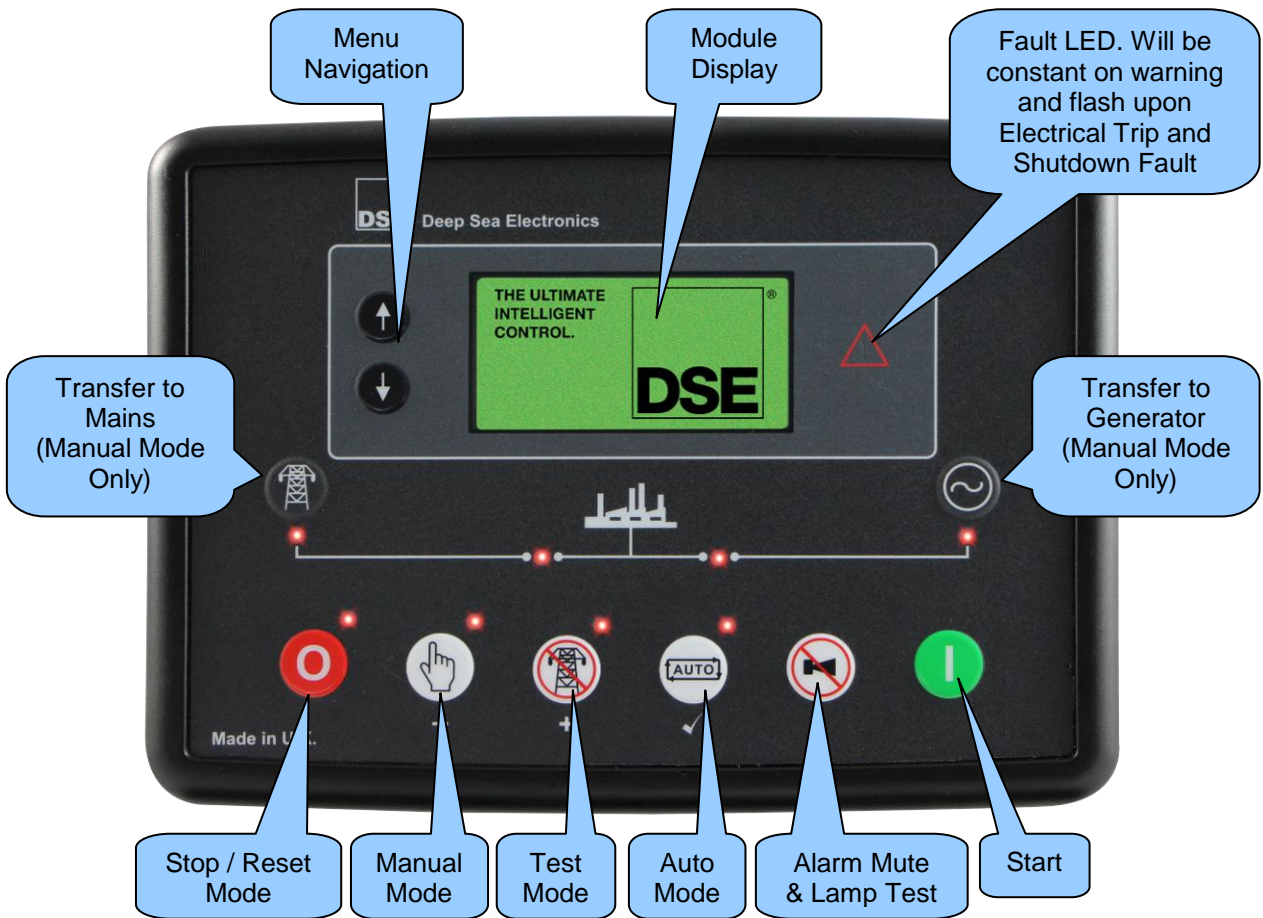









4.1 DSE6010 MKII

















4.2 DSE6020 MKII











4.3 CONTROL PUSH-BUTTONS

Icon	Description
	<p>Stop / Reset Mode</p> <p>This button places the module into its <i>Stop/Reset Mode</i> . This clears any alarm conditions for which the triggering criteria have been removed. If the engine is running and the module is put into Stop mode, the module automatically instructs the generator to unload (<i>Close Generator and Delayed Load Output 1, 2, 3 & 4 become inactive (if used)</i>). The fuel supply de-energises and the engine comes to a standstill. Should any form of <i>remote start signal</i> be present when in <i>Stop Mode</i> the generator remains at rest</p>
	<p>Manual Mode</p> <p>This button places the module into its <i>Manual Mode</i> . Once in <i>Manual Mode</i> , the module responds to the <i>Start</i>  button to start the generator and run it off load.</p> <p>To place the generator on load, use the <i>Transfer to Generator</i>  button. The module automatically instructs the changeover device to place the generator on load (<i>'Close Generator' and Delayed Load Output 1, 2, 3 & 4 becomes active (if used)</i>). To place the generator off load, use the <i>Transfer to Mains</i>  or <i>Open Generator</i>  buttons. The module automatically instructs the changeover device to place the generator off load (<i>Close Generator and Delayed Load Output 1, 2, 3 & 4 becomes inactive (if used)</i>). Additional digital inputs can be assigned to perform these functions.</p> <p>If the engine is running off-load in <i>Manual Mode</i>  and a remote start signal becomes present, the module automatically instructs the changeover device to place the generator on load (<i>'Close Generator' and 'Delayed Load Output 1, 2, 3 & 4' becomes active (if used)</i>). Upon removal of the <i>Remote Start Signal</i>, the generator remains on load until either selection of the <i>Stop/Reset Mode</i>  or <i>Auto Mode</i> .</p> <p><i>For further details, please see section entitled 'Operation' elsewhere in this manual.</i></p>
	<p>Test Mode (DSE6020 MKII Only)</p> <p>This button places the module into its <i>Test Mode</i> . Once in <i>Test Mode</i> , the module responds to the <i>Start</i>  button to start the generator and run it off load.</p> <p>Once the set has started the set automatically be placed on load (<i>Close Generator and Delayed Load Output 1, 2, 3 & 4 become active in order from lowest to highest (if used)</i>).</p> <p><i>For further details, please see section entitled 'Operation' elsewhere in this manual.</i></p>

Icon	Description
	<p>Auto Mode</p> <p>This button places the module into its <i>Auto Mode</i> . This mode allows the module to control the function of the generator automatically. The module monitors the <i>remote start</i> input and once a start request is made, the set is automatically started and placed on load (<i>Close Generator and Delayed Load Output 1, 2, 3 & 4 become active in order from lowest to highest (if used)</i>).</p> <p>Upon removal of the starting signal, the module removes the load from the generator and shut the set down observing the <i>stop delay</i> timer and <i>cooling</i> timer as necessary (<i>Close Generator and Delayed Load Output 1, 2, 3 & 4 become inactive at once (if used)</i>). The module then waits for the next start event.</p> <p><i>For further details, please see section entitled Operation elsewhere in this manual.</i></p>
	<p>Alarm Mute / Lamp Test</p> <p>This button de-activates the audible alarm output (if configured) and illuminates all of the LEDs on the module's fascia.</p>
	<p>Start</p> <p>This button is only active in the <i>Stop/Reset Mode</i> , <i>Manual Mode</i>  and <i>Test Mode</i> .</p> <p>Pressing the <i>Start</i>  button in <i>Stop/Reset Mode</i>  powers up the ECU but does not start the engine. This can be used to check the status of the CAN communication and to prime the fuel system.</p> <p>Pressing the <i>Start</i>  button in <i>Manual Mode</i>  or <i>Test Mode</i>  starts the generator and runs it off load in <i>Manual Mode</i>  or on load in <i>Test Mode</i> .</p>

Description Of Controls

Icon	Description
 	<p>Menu Navigation</p> <p>Used for navigating the instrumentation, event log and configuration screens.</p> <p><i>For further details, please see section entitled 'Operation' elsewhere in this manual.</i></p>
	<p>Transfer To Generator</p> <p>This button is only active in the <i>Manual Mode</i>  and allows the operator to transfer the load to the generator.</p>
	<p>Open Generator (DSE6010 MKII Only)</p> <p>This button is only active in the <i>Manual Mode</i>  and allows the operator to open the generator breaker and remove the load.</p>
	<p>Transfer To Mains (DSE6020 MKII Only)</p> <p>This button is only active in the <i>Manual Mode</i>  and allows the operator to transfer the load to the mains.</p>





4.4 MODULE DISPLAY

The module's display contains the following sections.

▲NOTE: Depending upon the module's configuration, some display screens may be disabled. For further details of module configuration, refer to DSE Publication: *057-223 DSE60xx MKII Configuration Software Manual*.

<i>Inst. Icon</i>	Instrumentation	Unit	<i>Alarm Icon</i>
<i>Active Config</i>	Instrumentation	Unit	
<i>FPE / Auto Run</i>	Instrumentation	Unit	<i>Mode Icon</i>

Example of DSE6010 MKII Home Page Display

	L1N	230	V	≡
	L2N	230	V	
	L3N	230	V	

Example of DSE6020 MKII Home Page Display



















	230	V	L1N	230	V	≡
	230	V	L2N	230	V	
	230	V	L3N	230	V	

4.4.1 BACKLIGHT

The LCD backlight is on if the unit has sufficient voltage while the unit is turned on, unless the unit is cranking for which the backlight is turned off.



4.4.2 INSTRUMENTATION ICONS

When viewing instrumentation pages, an icon is displayed in the *Inst. Icon* section to indicate what section is currently being displayed.

Icon	Details
	The default home page which displays generator voltage and mains voltage (DSE6020 MKII only)
	Generator voltage and frequency instrumentation screen
	Mains voltage and frequency instrumentation screen (DSE6020 MKII only)
	Generator current instrumentation screen
	Mains current instrumentation screen (DSE6020 MKII only when CT in load location)
	Load power instrumentation screen
	Engine speed instrumentation screen
	Hours run instrumentation screen
	Battery voltage instrumentation screen
	Oil pressure instrumentation screen
	Coolant temperature instrumentation screen
	Flexible sensor instrumentation screen
	Appears when the event log is being displayed
	Current time held in the unit
	The current value of the scheduler run time and duration
	ECU diagnostic trouble codes
	Oil Filter maintenance timers
	Air Filter maintenance timers
	Fuel Filter maintenance timers



4.4.3 ACTIVE CONFIGURATION





An icon is displayed in the *Active Config* section to indicate the active configuration within the currently selected within the controller.

Icon	Details
	Appears when the main configuration is selected.
	Appears when the alternative configuration is selected.

4.4.4 FRONT PANEL EDITOR (FPE) / AUTO RUN ICON













NOTE: For further details about the Front Panel Editor, see the section entitled 'Front Panel Editor' elsewhere in this manual.

When running in *Auto Mode*  and on the Home  page, an icon is displayed in the *FPE / Auto Run* section to indicate the source of the auto start signal.

Icon	Auto Run Reason
	Appears when a remote start input is active
	Appears when a low battery run is active
	Mains failure
	Appears when a scheduled run is active

4.4.5 MODE ICON

An icon is displayed in the *Mode Icon* section to indicate the mode the controller is currently in.

Icon	Details
	Appears when the engine is at rest and the unit is in <i>Stop/Reset Mode</i>  .
	Appears when the engine is at rest and the unit in <i>Manual Mode</i>  .
	Appears when the engine is at rest and the unit is <i>Test Mode</i>  .
	Appears when the engine is at rest and the unit is in <i>Auto Mode</i>  .
	Appears when a timer is active, for example <i>cranking time, crank rest</i> etc.
	Appears when the engine is running, and all timers have expired, either on or off load. The animation speed is reduced when running in idle mode.
	Appears when the unit is in the front panel editor.
	Appears when a USB connection is made to the controller.
	Appears if either the configuration file or engine file becomes corrupted.

4.4.6 ALARM ICONS (PROTECTIONS)

An icon is displayed in the *Alarm Icon* section to indicate the alarm that is current active on the controller.

In the event of a warning alarm, the LCD only displays the *Alarm Icon*. In the event of an electrical trip or shutdown alarm, the module displays the *Alarm Icon* and the *Stop/Reset Mode*  button LED begins to flash.

If multiple alarms are active at the same time, the *Alarm Icon* automatically cycles through all the appropriate icons to indicate each alarm which is active.

Example:



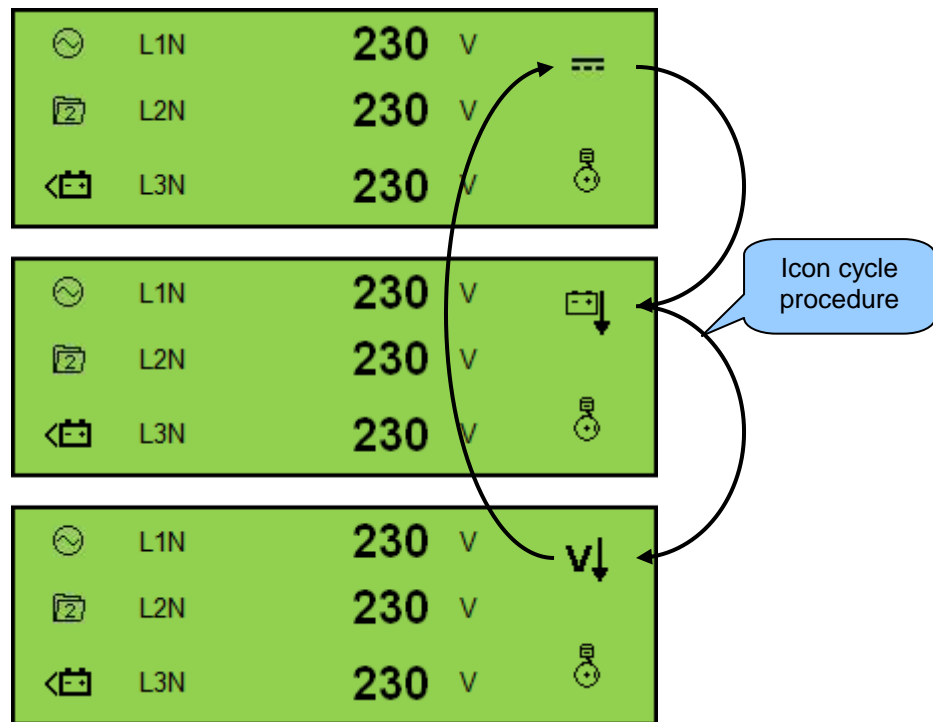















If the DSE controller was sensing a *charge alternator failure alarm*, *delay over current alarm* and a *AC under voltage alarm* at the same time, it would cycle through all of the icons to show this.



4.4.6.1 WARNING ALARM ICONS

Warnings are non-critical alarm conditions and do not affect the operation of the generator system, they serve to draw the operators attention to an undesirable condition.

By default, warning alarms are self-resetting when the fault condition is removed. However enabling *all warnings are latched* causes warning alarms to latch until reset manually. This is enabled using the DSE Configuration Suite in conjunction with a compatible PC.







Icon	Fault	Description
	Auxiliary Inputs	The module detects that an auxiliary input which has been user configured to create a fault condition has become active.
	Analogue Input	The module detects that an input configured to create a fault condition has become active.
	Fail To Stop	<div style="border: 2px solid black; padding: 5px;"> <p>NOTE: Fail to Stop could indicate a faulty oil pressure sensor. If engine is at rest check oil sensor wiring and configuration.</p> </div> <p>The module has detected a condition that indicates that the engine is running when it has been instructed to stop.</p>
	Charge Failure	The auxiliary charge alternator voltage is low as measured from the W/L terminal.
	Low Fuel Level	The level detected by the fuel level sensor is below the <i>low fuel level pre-set</i> pre-alarm setting.
	High Fuel Level	The level detected by the fuel level sensor is above the <i>high fuel level pre-set</i> pre-alarm setting.
	Battery Under Voltage	The DC supply has fallen below or risen above the <i>low volts pre-set</i> pre-alarm setting.
	Battery Over Voltage	The DC supply has risen above the <i>high volts pre-set</i> pre-alarm setting.
	Generator Under Voltage	The <i>generator output voltage</i> has fallen below the <i>pre-set</i> pre-alarm setting after the Safety On timer has expired.
	Generator Over Voltage	The <i>generator output voltage</i> has risen above the <i>pre-set</i> pre-alarm setting.
	Generator Under Frequency	The <i>generator output frequency</i> has fallen below the <i>pre-set</i> pre-alarm setting after the Safety On timer has expired.
	Generator Over Frequency	The <i>generator output frequency</i> has risen above the <i>pre-set</i> pre-alarm setting.
	CAN ECU Fault	The engine ECU has detected an alarm
	CAN Data Fail	The module is configured for CAN operation and does not detect data on the engine Can data link.
	Immediate Over Current	The measured current has risen above the configured trip level.
	Delayed Over Current	The measured current has risen above the configured trip level for a configured duration.
	Oil Filter Maintenance Alarm	Maintenance due for oil filter.
	Air Filter Maintenance Alarm	Maintenance due for air filter
	Fuel Filter Maintenance Alarm	Maintenance due for fuel filter.

4.4.6.2 ELECTRICAL TRIP ALARM ICONS

NOTE: The alarm condition must be rectified before a reset takes place. If the alarm condition remains, it is not possible to reset the unit (The exception to this is the *Low Oil Pressure alarm* and similar *active from safety on* alarms, as the oil pressure is low with the engine at rest).

Electrical trips are latching and stop the Generator but in a controlled manner. On initiation of the electrical trip condition the module de-energises all the *Delayed Load Output* and the *Close Gen Output* outputs to remove the load from the generator. Once this has occurred the module starts the Cooling timer and allows the engine to cool off-load before shutting down the engine. The alarm must be accepted and cleared, and the fault removed to reset the module.

Electrical trips are latching alarms and to remove the fault, press the *Stop/Reset Mode*  button on the module.













Icon	Fault	Description
	Auxiliary Inputs	The module detects that an auxiliary input which has been user configured to create a fault condition has become active.
	Analogue Input	The module detects that an input configured to create a fault condition has become active.
	Low Fuel Level	The level detected by the fuel level sensor is below the low fuel level pre-set alarm setting.
	High Fuel Level	The level detected by the fuel level sensor is above the high fuel level pre-set alarm setting.
	Delayed Over Current	The measured current has risen above the configured trip level for a configured duration.
	kW Overload	The measured kW has risen above the configured trip level for a configured duration.

4.4.6.3 SHUTDOWN ALARM ICONS

NOTE: The alarm condition must be rectified before a reset takes place. If the alarm condition remains, it is not possible to reset the unit (The exception to this is the *Low Oil Pressure alarm* and similar *active from safety on* alarms, as the oil pressure is low with the engine at rest).













Shutdown alarms are latching and immediately stop the Generator. On initiation of the shutdown condition the module de-energises all the *Delayed Load Output* and the *Close Gen Output* outputs to remove the load from the generator. Once this has occurred, the module shuts the generator set down immediately to prevent further damage. The alarm must be accepted and cleared, and the fault removed to reset the module.

Shutdowns are latching alarms and to remove the fault, press the *Stop/Reset Mode*  button on the module.

Icon	Fault	Description
	Auxiliary Inputs	The module detects that an auxiliary input which has been user configured to create a fault condition has become active.
	Analogue Input	The module detects that an input configured to create a fault condition has become active.
	Fail To Start	The engine has failed to start after the configured number of start attempts
	Low Oil Pressure	The module detects that the engine oil pressure has fallen below the low oil pressure pre-alarm setting level after the Safety On timer has expired.
	Engine High Temperature	The module detects that the engine coolant temperature has exceeded the high engine temperature pre-alarm setting level after the Safety On timer has expired.
	Under Speed	The engine speed has fallen below the under speed pre alarm setting
	Over Speed	The engine speed has risen above the over speed pre alarm setting
	Charge Failure	The auxiliary charge alternator voltage is low as measured from the W/L terminal.
	Low Fuel Level	The level detected by the fuel level sensor is below the low fuel level pre-set alarm setting.
	High Fuel Level	The level detected by the fuel level sensor is above the high fuel level pre-set alarm setting.
	Generator Under Voltage	The generator output voltage has fallen below the pre-set alarm setting. after the Safety On timer has expired.
	Generator Over Voltage	The generator output voltage has risen above the pre-set alarm setting.

Additional shutdown alarm icons can be viewed overleaf.

Description Of Controls



Icon	Fault	Description
	Generator Under Frequency	The generator output frequency has fallen below the pre-set alarm setting after the Safety On timer has expired.
	Generator Over Frequency	The generator output frequency has risen above the pre-set alarm setting.
	Delayed Over Current	The measured current has risen above the configured trip level for a configured duration.
	kW Overload	The measured kW has risen above the configured trip level for a configured duration.
	CAN ECU Fault	The engine ECU has detected an alarm – CHECK ENGINE LIGHT Contact Engine Manufacturer for support.
	CAN Data Fail	The module is configured for CAN operation and does not detect data on the engine Can data link.
	Emergency Stop	The emergency stop button has been depressed. This failsafe (normally closed to emergency stop) input and immediately stops the set should the signal be removed.
	Oil Sender Open Circuit	The oil pressure sensor has been detected as being open circuit.
	Coolant Temperature Sender Open Circuit	The coolant temperature sensor has been detected as being open circuit.
	Oil Filter Maintenance Alarm	Maintenance due for oil filter.
	Air Filter Maintenance Alarm	Maintenance due for air filter
	Fuel Filter Maintenance Alarm	Maintenance due for fuel filter.

4.5 VIEWING THE INSTRUMENT PAGES

4.5.1 NAVIGATION MENU

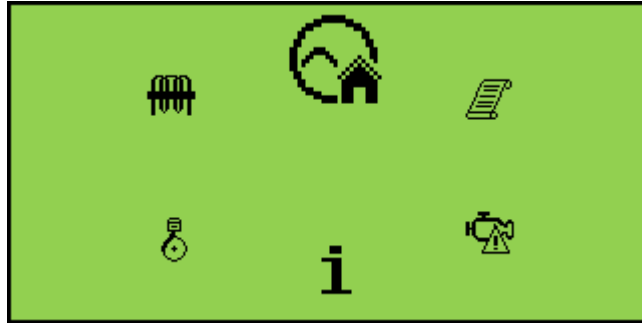

To enter the navigation menu, press both the  (up) and  (down) buttons simultaneously.



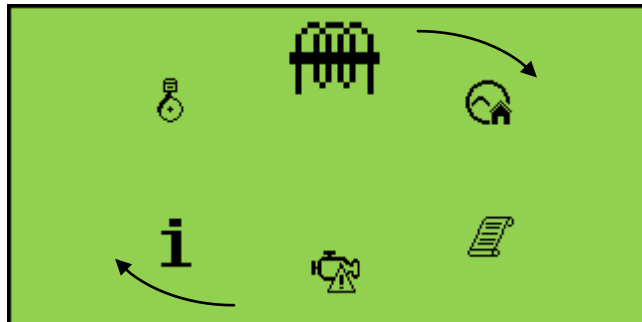







To select the required icon, press the  (up) button to cycle right or the  (down) button to cycle left until the desired instrumentation section is reached.



Once the desired icon is at the top, press the *Auto Mode*  (✓) button to enter that instrumentation section.



If the *Auto Mode*  (✓) button is not pressed, the display automatically returns to the Home  after the configured setting of the *LCD Scroll Timer*.

4.5.1.1 NAVIGATION MENU ICONS

Icon	Description
	Generator and mains voltage instrumentation (DSE6020 MKII only)
	Generator instrumentation
	Mains instrumentation (DSE6020 MKII only)
	Current and load instrumentation
	Engine instrumentation
	Module information
	Engine DTCs (Diagnostic Trouble Codes) if active
	Event Log

4.5.2 GENERAL NAVIGATION



NOTE: For further details of module configuration, refer to DSE Publication: 057-223 *DSE60xx MKII Configuration Software Manual*.

It is possible to scroll through the display to view different pages of information by repeatedly operating the  (up) or  (down) navigation buttons.

If you want to view one of the instrument pages towards the end of the list, it may be quicker to scroll up through the pages rather than down!

Example:



And so on until the last page is reached. A Further press of the navigation  (down) button returns the display to the Home  page.

Once selected, the page remains on the LCD display until the user selects a different page or, after an extended period of inactivity (*Page Delay Timer*), the module reverts back to the Home  page.

The *Page Delay Timer* is configurable using the DSE Configuration Suite Software or by using the Front Panel Editor.

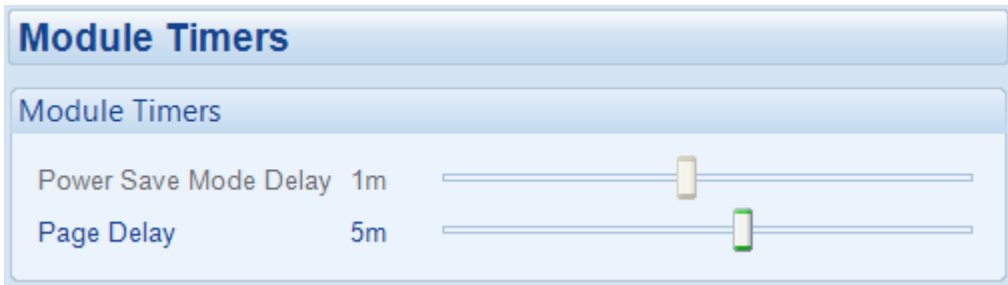

4.5.3 HOME

This is the page that is displayed when no other page has been selected and is automatically displayed after a period of inactivity (*Page Delay Timer*) of the module facia buttons. It also contains the voltage reading of the generator and mains that is measured from the module's voltage inputs.

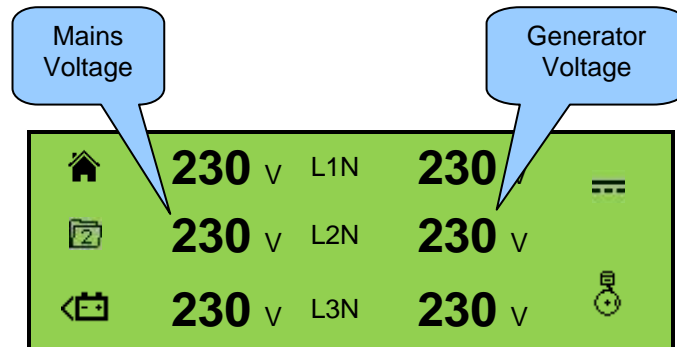

- Generator Voltage (ph-N / ph-ph)
- Mains Voltage (ph-N / ph-ph) (DSE6020 MKII only)

4.5.4 GENERATOR



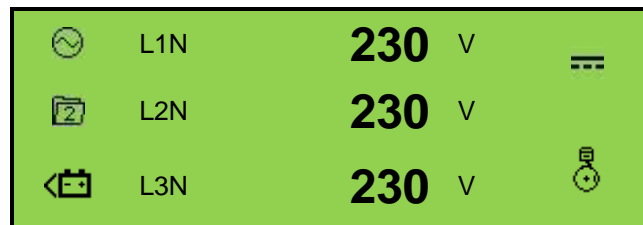

These pages contain electrical values of the generator, measured or derived from the module's voltage inputs.



- Generator Voltage (ph-N)
- Generator Voltage (ph-ph)
- Generator Frequency

4.5.5 MAINS (DSE6020 MKII ONLY)





These pages contain electrical values of the mains, measured or derived from the module's voltage inputs.

	L1N	230	V	
	L2N	230	V	
	L3N	230	V	

- Mains Voltage (ph-N)
- Mains Voltage (ph-ph)
- Mains Frequency

4.5.6 LOAD

These pages contain electrical values of the load, measured or derived from the module's voltage and current inputs. The power values displayed depend on which supply is on load.

	L1	20	kW	
	L2	20	kW	
	L3	20	kW	

- Generator Current (A)
- Mains Current (A) (DSE6020 MKII only)
- Load ph-N (kW)
- Total Load (kW)
- Load ph-N (kVA)
- Total Load (kVA)
- Load ph-N (kVAr)
- Total Load (kVAr)
- Power Factor ph-N
- Power Factor Average
- Accumulated Load (kWh, kVAh, kVArh)

4.5.7 ENGINE

These pages contain instrumentation gathered about the engine measured or derived from the module's inputs, some of which may be obtained from the engine ECU.

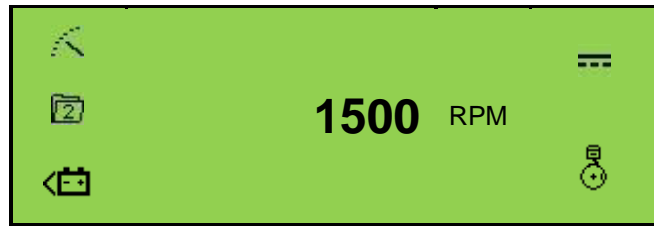

- Engine Speed
- Engine Run Time
- Engine Battery Volts
- Engine Coolant Temperature
- Engine Oil Pressure
- Engine Fuel Level
- Flexible Sensor
- Engine Maintenance Due – Oil
- Engine Maintenance Due – Air
- Engine Maintenance Due – Fuel

4.5.8 INFO

These pages contain information about the controller.

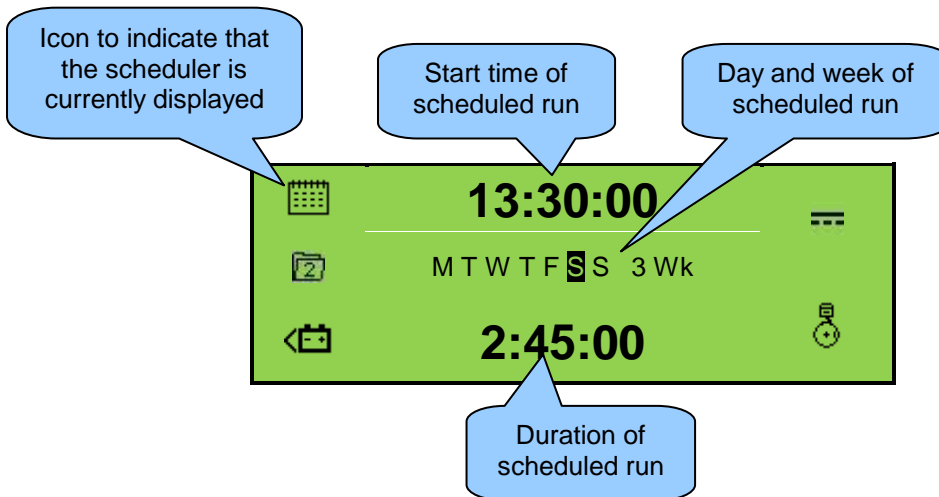

- Module's date and time
- Scheduler settings
- Product description and USB identification number
- Application and Engine Version

4.5.9 ENGINE DTC (ECU ALARMS)



NOTE: For details on these code meanings, refer to the ECU instructions provided by the engine manufacturer, or contact the engine manufacturer for further assistance.

NOTE: For further details on connection to electronic engines, refer to DSE Publication: *057-004 Electronic Engines And DSE Wiring*



If the DSE module is connected to an ECU, This page contains active *Diagnostic Trouble Codes (DTC)* only if the engine ECU generating a fault code. These are alarm conditions are detected by the engine ECU and displayed by the DSE controller.

4.5.9.1 VIEWING ACTIVE ENGINE DTC

To view the engine DTC(s), press both  (up) and  (down) buttons simultaneously, the navigation menu is then displayed. Once entered, cycle to the DTC () section and enter.

To view the active DTC(s) alarms, repeatedly press the  (up) or  (down) buttons until the LCD screen displays the alarm.





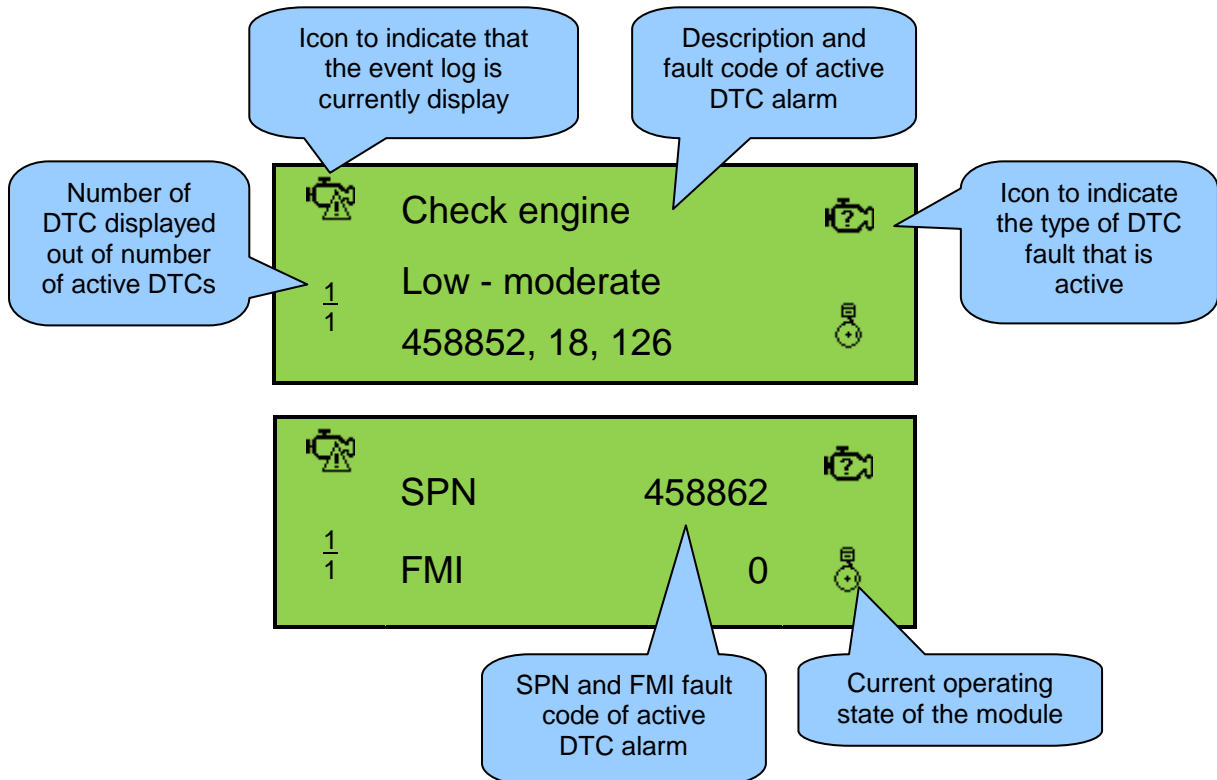

Continuing to press the  (up) or  (down) buttons cycles through the alarms.

To exit the active DTC(s) alarm section, press the  (up) and  (down) buttons simultaneously to enter the navigation menu. Once entered, cycle to the desired instrumentation section.



A list of CAN fault icons can be viewed overleaf.

Description Of Controls

Icon	Fault	DTC Description
	Check Engine Fault	The engine ECU has detected a fault not recognised by the DSE module, contact engine manufacturer for support.
	Low Oil Pressure	The engine ECU has detected that the engine oil pressure has fallen below its configured low oil pressure alarm level.
	Under Speed	The engine ECU has detected that the engine speed has fallen below its configured under speed alarm level.
	Over Speed	The engine ECU has detected that the engine speed has risen above its configured over speed alarm level.
	Charge Failure	The engine ECU has detected that the engine's charge alternator output has fallen below its configured alarm level.
	Low Fuel Level	The engine ECU has detected that the engine's fuel level has fallen below its configured low fuel level alarm.
	Battery Under/Over Voltage	The engine ECU has detected that the engine's DC supply has fallen below or risen above its configured alarm level.

4.5.10 EVENT LOG

NOTE: For further details of module configuration, refer to DSE Publication: 057-223 *DSE60xx MKII Configuration Software Manual*.

This module's event log contains a list of the last 50 recorded events and the engine hours at which they occurred. The events recorded are customisable via the DSE Configuration Suite PC Software.

Event Log

Display Options

Module display Date and time Engine hours run

Logging Options

Log the following events to the event log



Power up	<input checked="" type="checkbox"/>	Shutdown alarms	<input checked="" type="checkbox"/>
Mains return	<input checked="" type="checkbox"/>	Electrical trip alarms	<input checked="" type="checkbox"/>
Mains fail	<input checked="" type="checkbox"/>	Latched warnings	<input checked="" type="checkbox"/>
ECU Shutdown alarms	<input checked="" type="checkbox"/>	Unlatched warnings	<input checked="" type="checkbox"/>
		Maintenance alarms	<input checked="" type="checkbox"/>



Example showing the possible configuration of the event log (DSE Configuration Suite Software).



This also shows the factory settings of the module.

Once the log is full, any subsequent event overwrites the oldest entry in the log. Hence, the log always contains the most recent events. The module logs the alarm, along with the engine running hours.

4.5.10.1 VIEWING THE EVENT LOG

To view the event log, press both  (up) and  (down) buttons simultaneously, the navigation menu is then displayed. Once entered, cycle to the event log () section and enter.

To view the event log, repeatedly press the  (up) or  (down) buttons until the LCD screen displays the desired event.

Continuing to press down the  (up) or  (down) buttons cycles through the past alarms after which the display shows the most recent alarm and the cycle begins again.

To exit the event log, press the  (up) and  (down) buttons simultaneously to enter the navigation menu. Once entered, cycle to the desired instrumentation section.

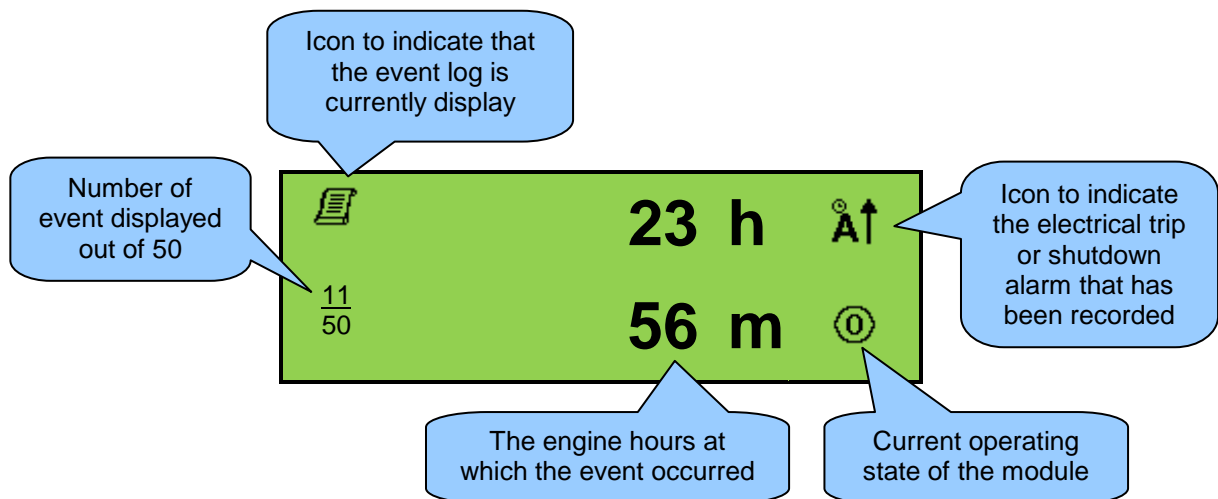

5 OPERATION

NOTE: The following descriptions detail the sequences followed by a module containing the standard 'factory configuration'. Always refer to your configuration source for the exact sequences and timers observed by any particular module in the field.

5.1 QUICKSTART GUIDE

This section provides a quick start guide to the module's operation.

5.1.1 STARTING THE ENGINE

NOTE: For further details, see the section entitled 'OPERATION' elsewhere in this manual.



5.1.2 STOPPING THE ENGINE

NOTE: For further details, see the section entitled 'OPERATION' elsewhere in this manual.

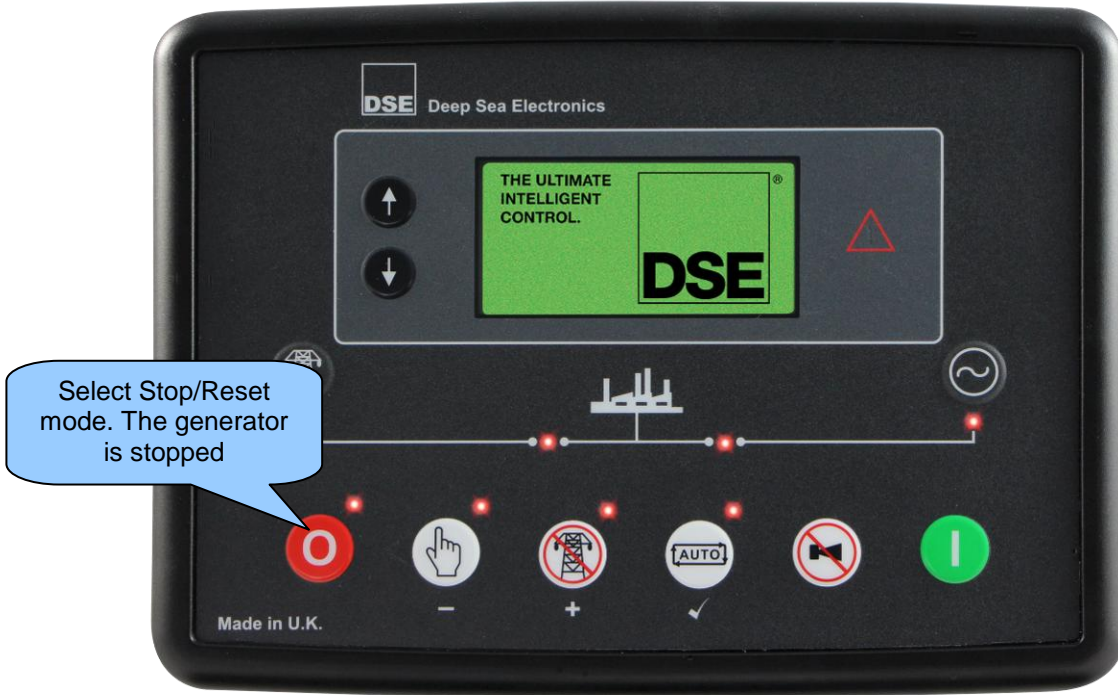

5.2 STOP/RESET MODE

NOTE: If a digital input configured to *Panel Lock* is active, changing module modes is not possible. Viewing the instruments and event logs is NOT affected by *Panel Lock*.

NOTE: For further details of module configuration, refer to DSE Publication: *057-223 DSE60xx MKII Configuration Software Manual*.

Stop/Reset Mode is activated by pressing the *Stop/Reset Mode*  button.

The *Stop/Reset Mode*  icon is displayed to indicate *Stop/Reset Mode* operations.

In *Stop/Reset Mode* , the module removes the generator from load (if necessary) before stopping the engine if it is already running.

If the engine does not stop when requested, the FAIL TO STOP alarm is activated (subject to the setting of the *Fail to Stop* timer). To detect the engine at rest the following must occur :

- Engine speed is zero as detected by the CAN ECU
- Generator AC Voltage and Frequency must be zero.
- Engine Charge Alternator Voltage must be zero.
- Oil pressure sensor must indicate low oil pressure

When the engine has stopped, it is possible to send configuration files to the module from DSE Configuration Suite PC software and to enter the Front Panel Editor to change parameters.

Any latched alarms that have been cleared are reset when *Stop/Reset Mode*  is entered.

The engine is not started when in *Stop/Reset Mode* . If remote start signals are given, the input is ignored until *Auto Mode*  is entered.

When left in *Stop/Reset Mode*  with no presses of the fascia buttons and configured for *Power Save Mode*, the module enters *Power Save Mode*. To 'wake' the module, press any fascia control buttons.

Power Save Mode in the DSE Configuration Suite Software



Power Save Mode Enable





5.3 MANUAL MODE

 **NOTE: If a digital input configured to Panel Lock is active, changing module modes is not be possible. Viewing the instruments and event logs is NOT affected by panel lock.**

Manual Mode is activated by pressing the *Manual Mode*  button.

The *Manual Mode*  icon is displayed to indicate *Manual Mode*  operations.

In *Manual Mode* , the set does not start automatically

To begin the starting sequence, press the *Start*  button.

5.3.1 STARTING SEQUENCE

 **NOTE: There is no *start delay* in this mode of operation.**

 **NOTE: If the unit has been configured for CAN, compatible ECU's receives the start command via CAN.**

 **NOTE: For further details of module configuration, refer to DSE Publication: 057-223 *DSE60xx MKII Configuration Software Manual*.**

The fuel relay is energised and the engine is cranked.

If the engine fails to fire during this cranking attempt then the starter motor is disengaged for the *Crank Rest Timer* duration after which the next start attempt is made. Should this sequence continue beyond the set *Number Of Attempts*, the start sequence is terminated and the display shows  *Fail to Start*.

The starter motor is disengaged when the engine fires. Speed detection is factory configured to be derived from the AC alternator output frequency, but can additionally be measured from a Magnetic Pickup mounted on the flywheel or from the CANbus link to the engine ECU depending on module configuration.

Additionally, rising oil pressure can be used to disconnect the starter motor (but cannot detect underspeed or overspeed).

After the starter motor has disengaged, the *Safety On Delay* timer activates, allowing Oil Pressure, High Engine Temperature, Under-speed, Charge Fail and any delayed Auxiliary fault inputs to stabilise without triggering the fault.

5.3.2 ENGINE RUNNING





NOTE: The load transfer signal remains inactive until the Oil Pressure has risen. This prevents excessive wear on the engine.

Once the engine is running and all starting timers have expired, the animated *Engine Running*  icon is displayed.

In **Manual Mode** , the load is not transferred to the generator unless a 'loading request' is made. A loading request can come from a number of sources.



- Press the *Transfer to Generator*  button
- Failure of mains supply (DSE6020 MKII only)
- Activation of an auxiliary input that has been configured to *Remote Start On Load or Auxiliary Mains Fail* (DSE6020 MKII Only).
- Activation of the inbuilt exercise scheduler if configured for 'on load' runs.

Once the generator has been placed on load, it is not automatically removed. To manually remove the load either:

- Press the *Open Generator*  (DSE6010 MKII Only) or *Transfer to Mains*  (DSE6020 MKII Only) button
- Press the *Auto Mode*  button to return to automatic mode. The set observes all *Auto Mode*  start requests and stopping timers before beginning the *Auto Mode Stopping Sequence*.
- Press the *Stop/Reset Mode*  button to remove load and stop the generator.
- Activation of an auxiliary input that has been configured to *Generator Load Inhibit*.

5.3.3 STOPPING SEQUENCE



In **Manual Mode** , the set does not continue to run until either:

- The *Stop/Reset Mode*  button is pressed – The delayed load outputs are de-activated immediately and the set immediately stops.
- The *Auto Mode*  button is pressed. The set observes all *Auto Mode*  start requests and stopping timers before beginning the *Auto Mode Stopping Sequence*.

5.4 TEST MODE

▲ NOTE: If a digital input configured to *Panel Lock* is active, changing module modes is not be possible. Viewing the instruments and event logs is NOT affected by *Panel Lock*.

Test Mode is activated by pressing the *Test Mode*  button.

The *Test Mode*  icon is displayed to indicate *Test Mode*  operations.

In *Test Mode* , the set does not start automatically.

To begin the starting sequence, press the *Start*  button.

5.4.1 STARTING SEQUENCE

▲ NOTE: There is no *Start Delay* in this mode of operation.

▲ NOTE: If the unit has been configured for CAN, compatible ECU's receives the start command via CAN.

▲ NOTE: For further details of module configuration, refer to DSE Publication: 057-223 *DSE60xx MKII Configuration Software Manual*.

The fuel relay is energised and the engine is cranked.

If the engine fails to fire during this cranking attempt then the starter motor is disengaged for the *crank rest* duration after which the next start attempt is made. Should this sequence continue beyond the set number of attempts, the start sequence is terminated and the display shows  *Fail to Start*.

The starter motor is disengaged when the engine fires. Speed detection is factory configured to be derived from the AC alternator output frequency, but can additionally be measured from a Magnetic Pickup mounted on the flywheel or from the CANbus link to the engine ECU depending on module configuration.

Additionally, rising oil pressure can be used to disconnect the starter motor (but cannot detect underspeed or overspeed).

After the starter motor has disengaged, the *Safety On Delay* timer activates, allowing Oil Pressure, High Engine Temperature, Under-speed, Charge Fail and any delayed Auxiliary fault inputs to stabilise without triggering the fault.







5.4.2 ENGINE RUNNING

NOTE: The load transfer signal remains inactive until the Oil Pressure has risen. This prevents excessive wear on the engine.

Once the engine is running and all starting timers have expired, the animated *Engine Running*  icon is displayed.



In *Test Mode* , the load is automatically transferred to the generator.

Once the generator has been placed on load, it is not automatically removed. To manually remove the load either:

- Press the *Manual Mode*  button followed by the *Open Generator*  (DSE6010 MKII Only) or *Transfer to Mains*  (DSE6020 MKII Only) button.
- Press the *Auto Mode*  button to return to automatic mode. The set observes all *Auto Mode*  start requests and stopping timers before beginning the *Auto Mode Stopping Sequence*.
- Press the *Stop/Reset Mode*  button to remove load and stop the generator.
- Activation of an auxiliary input that has been configured to *Generator Load Inhibit*.

5.4.3 STOPPING SEQUENCE



In *Test Mode*  the set continues to run until either:

- The *Stop/Reset Mode*  button is pressed – The delayed load outputs are de-activated immediately and the set immediately stops.
- The *Auto Mode*  button is pressed. The set observes all *Auto Mode*  start requests and stopping timers before beginning the *Auto Mode Stopping Sequence*.

5.5 AUTOMATIC MODE

NOTE: If a digital input configured to external *Panel Lock* is active, changing module modes is not possible. Viewing the instruments and event logs is NOT affected by *Panel Lock*.

Auto Mode is activated by pressing the *Auto Mode*  button.

The *Auto Mode*  icon is displayed to indicate *Auto Mode*  operations.

Auto Mode  allows the generator to operate fully automatically, starting and stopping as required with no user intervention.

5.5.1 WAITING IN AUTO MODE

If a starting request is made, the starting sequence begins. Starting requests can be from the following sources:

- Failure of mains supply (DSE6020 MKII only)
- Activation of an auxiliary input that has been configured to *Remote Start or Auxiliary Mains Fail* (DSE6020 MKII Only).
- Activation of the inbuilt exercise scheduler.

5.5.2 STARTING SEQUENCE

NOTE: If the unit has been configured for CAN, compatible ECU's receive the start command via CAN and transmit the engine speed to the DSE controller.

NOTE: For further details of module configuration, refer to DSE Publication: 057-223 *DSE60xx MKII Configuration Software Manual*.

To allow for 'false' start requests, the *start delay* timer begins.

Should all start requests be removed during the *start delay* timer, the unit returns to a stand-by state.

If a start request is still present at the end of the *start delay* timer, the fuel relay is energised and the engine is cranked.

If the engine fails to fire during this cranking attempt then the starter motor is disengaged for the *Crank Rest* duration after which the next start attempt is made. Should this sequence continue beyond the *Set Number Of Attempts*, the start sequence is terminated and the display shows  *Fail to Start*.

The starter motor is disengaged when the engine fires. Speed detection is factory configured to be derived from the AC alternator output frequency, but can additionally be measured from a Magnetic Pickup mounted on the flywheel or from the CAN link to the engine ECU depending on module

Additionally, rising oil pressure can be used to disconnect the starter motor (but cannot detect underspeed or overspeed).

After the starter motor has disengaged, the *Safety On Delay* timer activates, allowing Oil Pressure, High Engine Temperature, Under-speed, Charge Fail and any delayed Auxiliary fault inputs to stabilise without triggering the fault.

5.5.3 ENGINE RUNNING

 **NOTE: The load transfer signal remains inactive until the Oil Pressure has risen. This prevents excessive wear on the engine.**

Once the engine is running and all starting timers have expired, the animated *Engine Running*  icon is displayed.

The generator is placed on load if configured to do so.

If all start requests are removed, the *stopping sequence* begins.

5.5.4 STOPPING SEQUENCE

The *Return Delay* timer operates to ensure that the starting request has been permanently removed and isn't just a short term removal. Should another start request be made during the cooling down period, the set returns on load.

If there are no starting requests at the end of the *Return Delay* timer, the load is removed from the generator to the mains supply and the *cooling* timer is initiated.

The *Cooling Down* timer allows the set to run off load and cool sufficiently before being stopped. This is particularly important where turbo chargers are fitted to the engine.

After the *Cooling Down* timer has expired, the set is stopped.

5.6 MAINTENANCE ALARM

Depending upon module configuration one or more levels of engine maintenance alarm may occur based upon a configurable schedule.

Example 1

Screen capture from DSE Configuration Suite Software showing the configuration of the *Maintenance Alarm* for Oil, Air and Fuel.

When activated, the maintenance alarm can be either a *Warning* (set continues to run) or *Shutdown* (running the set is not possible).

Resetting the *Maintenance Alarm* is normally actioned by the site service engineer after performing the required maintenance.

The method of reset is either by:

- Activating an input that has been configured to *Maintenance Reset Alarm x*, where x is the type of maintenance alarm (Air, Fuel or Oil).
- Pressing the maintenance reset button in the DSE Configuration Suite, Maintenance section.
- Pressing and holding the *Stop/Reset Mode*  button for 10 seconds on the desired Maintenance Alarm status page. This can be protected by a PIN number.

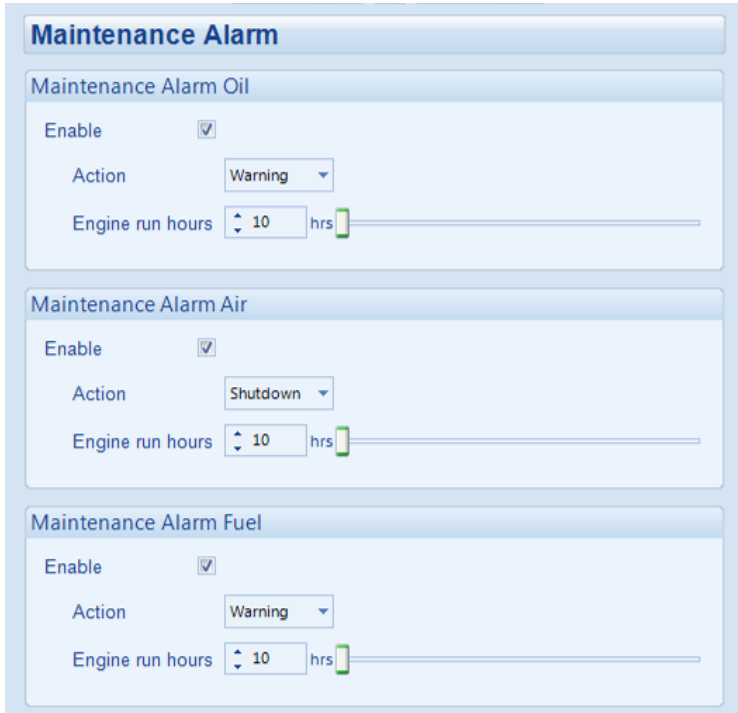

Maintenance Alarm

Maintenance Alarm Oil

Enable

Action Warning

Engine run hours 10 hrs

Maintenance Alarm Air

Enable

Action Shutdown

Engine run hours 10 hrs

Maintenance Alarm Fuel

Enable

Action Warning

Engine run hours 10 hrs

Example 2

Screen capture from DSE Configuration Suite Software showing the configuration of a digital input for Maintenance Reset Alarm Air.

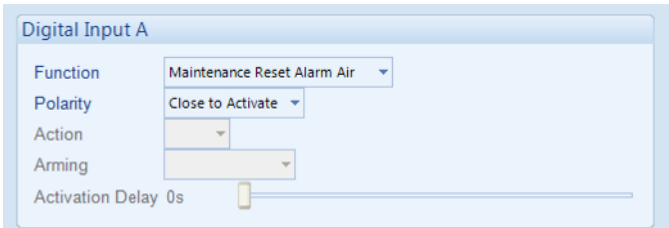

Digital Input A

Function Maintenance Reset Alarm Air

Polarity Close to Activate

Action

Arming

Activation Delay 0s

Example 3

Screen capture from DSE Configuration Suite Software showing the Maintenance Alarm Reset 'button' in the DSE Configuration Suite SCADA | MAINTENANCE section.

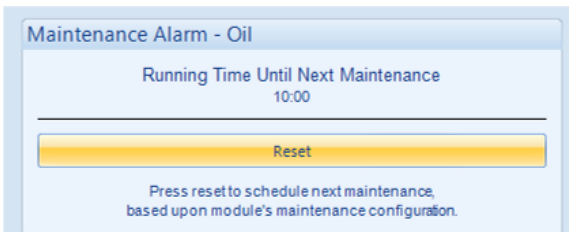

Maintenance Alarm - Oil

Running Time Until Next Maintenance
10:00

Reset

Press reset to schedule next maintenance,
based upon module's maintenance configuration.

5.7 SCHEDULER

The controller contains an inbuilt exercise run scheduler, capable of automatically starting and stopping the set. Up to 8 scheduled start/stop sequences can be configured to repeat on a 7-day or 28-day cycle.

Scheduled runs may be on load or off load depending upon module configuration.

Example

Screen capture from DSE Configuration Suite Software showing the configuration of the Exercise Scheduler.



In this example the set starts at 09:00 on Monday and run for 5 hours, then start at 13:30 on Tuesday and run for 30 minutes.

Week	Day	Start Time	Duration	
	Monday	09:00	05:00	Clear
	Tuesday	13:30	00:30	Clear
	Monday	00:00	00:00	Clear
	Monday	00:00	00:00	Clear
	Monday	00:00	00:00	Clear
	Monday	00:00	00:00	Clear
	Monday	00:00	00:00	Clear
	Monday	00:00	00:00	Clear
	Monday	00:00	00:00	Clear

5.7.1 STOP MODE

- Scheduled runs do not occur when the module is in *Stop/Reset Mode* .





5.7.2 MANUAL MODE

- Scheduled runs do not occur when the module is in *Manual Mode*  waiting for a start request.
- Activation of a Scheduled Run 'On Load' when the module is operating OFF LOAD in *Manual Mode*  forces the set to run ON LOAD.

5.7.3 TEST MODE

- Scheduled runs do not occur when the module is in *Test Mode*  waiting for a start request.

5.7.4 AUTO MODE

- Scheduled runs operate ONLY if the module is in *Auto Mode*  with no Shutdown or Electrical Trip alarm present.
- If the module is in *Stop/Reset Mode*  or *Manual Mode*  when a scheduled run begins, the engine is not started. However, if the module is moved into *Auto Mode*  during a scheduled run, the engine is called to start.
- Depending upon configuration by the system designer, an external input can be used to inhibit a scheduled run.
- If the engine is running OFF LOAD in *Auto Mode*  and a scheduled run configured to 'On Load' begins, the set is placed ON LOAD for the duration of the Schedule.



6 FRONT PANEL CONFIGURATION

This configuration mode allows the operator to fully configure the module through its display without the use of the DSE Configuration Suite PC Software.

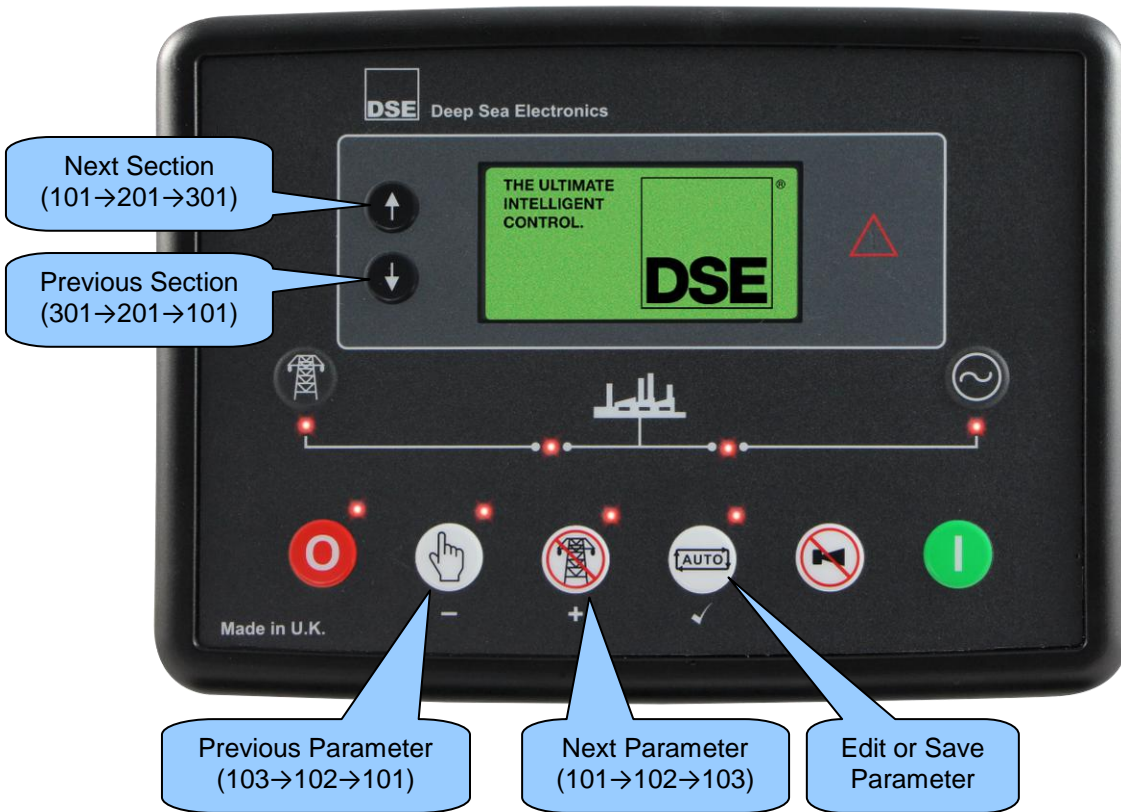
Use the module's facia buttons to traverse the menu and make value changes to the parameters:



6.1 ACCESSING THE FRONT PANEL CONFIGURATION EDITOR

 **NOTE:** Pressing and holding the  or  navigation buttons provides the auto-repeat functionality. Values can be changed quickly by holding the navigation buttons for a prolonged period of time.









 **NOTE:** The editor automatically exits after 5 minutes of inactivity to ensure security.

 **NOTE:** The PIN number is not set by DSE when the module leaves the factory. If the module has a PIN code set, this has been affected by your generator supplier who should be contacted if you require the code. If the code has been 'lost' or 'forgotten', the module must be returned to the DSE factory to have the module's code removed. A charge is made for this procedure.

NB - This procedure cannot be performed away from the DSE factory.

 **NOTE:** The PIN number is automatically reset when the editor is exited (manually or automatically) to ensure security.

 **NOTE:** More comprehensive module configuration is possible via PC configuration software. For further details of module configuration, refer to DSE Publication: 057- 223 DSE60xx MKII Configuration Software Manual.

- Press the *Stop/Reset Mode*  and *Auto Mode*  (✓) buttons together to enter the editor  mode.
- Press the  (up) or  (down) navigation buttons to cycle through the front panel editor in increments of 100.
- Press the (+) or (-) navigation buttons to cycle through the front panel editor in increments of 1.
- When viewing the parameter to be edited, press the *Auto Mode*  (✓) button and the value begins to flash.
- Press the (+) or (-) navigation buttons to adjust the value to the required setting.
- Press the *Auto Mode*  button to save the current value, the value ceases flashing.
- Press and hold the *Auto Mode*  button to save and exit the editor, the configuration icon  is removed from the display.

6.2 ADJUSTABLE PARAMETERS

6.2.1 MODULE SETTINGS

x	Functionality in DSE6010 MKII & DSE6020 MKII
x	Functionality in DSE6020 MKII only

Configuration Parameters – Module (Page 1)		
101	Contrast	0 (%)
102	Fast Loading Enabled	On (1), Off (0)
103	All Warnings Latched	On (1), Off (0)
104	Lamp Test At Startup	On (1), Off (0)
105	Power Save Mode Enable	On (1), Off (0)
106	RESERVED	
107	RESERVED	
108	Event Log Display Format	On (1), Off (0)
109	Power Up Mode	0 (Power Up Mode)
110	DTC String Enable	On (1), Off (0)
111	RESERVED	
112	Pin Protected Maintenance Reset	On (1), Off (0)
113	Stop Button Cooldown	On (1), Off (0)
114	Use Module Oil Pressure	On (1), Off (0)
115	Use Module Coolant Temp	On (1), Off (0)
116	Use Module Engine Hours	On (1), Off (0)
117	Use Module RPM	On (1), Off (0)
118	Use Module Charge Alt	On (1), Off (0)
119	Disable CAN Speed Control	On (1), Off (0)
120	CT Position	Gen (0), Load(1)
121	Generator Voltage Display	On (1), Off (0)
122	Mains Voltage Display	On (1), Off (0)
123	Generator Frequency Display	On (1), Off (0)
124	Mains Frequency Display	On (1), Off (0)
125	Current Display	On (1), Off (0)
126	kW Display	On (1), Off (0)
127	kVAr Display	On (1), Off (0)
128	kVA Display	On (1), Off (0)
129	pf Display	On (1), Off (0)
130	kWh Display	On (1), Off (0)
131	kVArh Display	On (1), Off (0)
132	kVAh Display	On (1), Off (0)
133	Hold Start Button to Crank	On (1), Off (0)

6.2.2 CAN SETTINGS

Configuration Parameters – Can Application (Page 2)		
201	CAN Alternative Engine Speed	On (1), Off (0)
202	CAN ECU Data Fail Enable	On (1), Off (0)
203	CAN ECU Data Fail Action	0 (Action)
204	CAN ECU Data Fail Delay	0 s

6.2.3 INPUT SETTINGS

Configuration Parameters – Inputs (Page 3)		
301	Digital Input A Source	0 (Input Source)
302	Digital Input A Polarity	0 (Polarity)
303	Digital Input A Action (If Source = User Config)	0 (Action)
304	Digital Input A Arming (If Source = User Config)	0 (Arming)
305	Digital Input A Activation Delay (If Source = User Config)	0 s
306	Digital Input B Source	0 (Input Source)
307	Digital Input B Polarity	0 (Polarity)
308	Digital Input B Action (If Source = User Config)	0 (Action)
309	Digital Input B Arming (If Source = User Config)	0 (Arming)
310	Digital Input B Activation Delay (If Source = User Config)	0 s
311	Digital Input C Source	0 (Input Source)
312	Digital Input C Polarity	0 (Polarity)
313	Digital Input C Action (If Source = User Config)	0 (Action)
314	Digital Input C Arming (If Source = User Config)	0 (Arming)
315	Digital Input C Activation Delay (If Source = User Config)	0 s
316	Digital Input D Source	0 (Input Source)
317	Digital Input D Polarity	0 (Polarity)
318	Digital Input D Action (If Source = User Config)	0 (Action)
319	Digital Input D Arming (If Source = User Config)	0 (Arming)
320	Digital Input D Activation Delay (If Source = User Config)	0 s
321	Digital Input E Source	0 (Input Source)
322	Digital Input E Polarity	0 (Polarity)
323	Digital Input E Action (If Source = User Config)	0 (Action)
324	Digital Input E Arming (If Source = User Config)	0 (Arming)
325	Digital Input E Activation Delay (If Source = User Config)	0 s
326	Digital Input F Source	0 (Input Source)
327	Digital Input F Polarity	0 (Polarity)
328	Digital Input F Action (If Source = User Config)	0 (Action)
329	Digital Input F Arming (If Source = User Config)	0 (Arming)
330	Digital Input F Activation Delay (If Source = User Config)	0 s
331	Analogue Input A (Set As Digital) Source	0 (Input Source)
332	Analogue Input A (Set As Digital) Polarity	0 (Polarity)
333	Analogue Input A (Set As Digital) Action (If Source = User Config)	0 (Action)
334	Analogue Input A (Set As Digital) Arming (If Source = User Config)	0 (Arming)
335	Analogue Input A (Set As Digital) Activation Delay (If Source = User Config)	0 s
336	Analogue Input B (Set As Digital) Source	0 (Input Source)
337	Analogue Input B (Set As Digital) Polarity	0 (Polarity)
338	Analogue Input B (Set As Digital) Action (If Source = User Config)	0 (Action)
339	Analogue Input B (Set As Digital) Arming (If Source = User Config)	0 (Arming)
340	Analogue Input B (Set As Digital) Activation Delay (If Source = User Config)	0 s
341	Analogue Input C (Set As Digital) Source	0 (Input Source)
342	Analogue Input C (Set As Digital) Polarity	0 (Polarity)
343	Analogue Input C (Set As Digital) Action (If Source = User Config)	0 (Action)
344	Analogue Input C (Set As Digital) Arming (If Source = User Config)	0 (Arming)
345	Analogue Input C (Set As Digital) Activation Delay (If Source = User Config)	0 s
346	Analogue Input D (Set As Digital) Source	0 (Input Source)
347	Analogue Input D (Set As Digital) Polarity	0 (Polarity)
348	Analogue Input D (Set As Digital) Action (If Source = User Config)	0 (Action)
349	Analogue Input D (Set As Digital) Arming (If Source = User Config)	0 (Arming)
350	Analogue Input D (Set As Digital) Activation Delay (If Source = User Config)	0 s

6.2.4 OUTPUT SETTINGS

x	Functionality in DSE6010 MKII & DSE6020 MKII
x	Functionality in DSE6020 MKII only

Configuration Parameters – Outputs (Page 4)		
401	Digital Output A Source	0 (Output Source)
402	Digital Output A Polarity	0 (Output Polarity)
403	Digital Output B Source	0 (Output Source)
404	Digital Output B Polarity	0 (Output Polarity)
405	Digital Output C Source	0 (Output Source)
406	Digital Output C Polarity	0 (Output Polarity)
407	Digital Output D Source	0 (Output Source)
408	Digital Output D Polarity	0 (Output Polarity)
409	Digital Output E Source	0 (Output Source)
410	Digital Output E Polarity	0 (Output Polarity)
411	Digital Output F Source	0 (Output Source)
412	Digital Output F Polarity	0 (Output Polarity)

6.2.5 TIMER SETTINGS

Configuration Parameters – Timers (Page 5)	
501	Mains Transient Delay
502	Start Delay
503	Preheat Timer
504	Crank Time
505	Crank Rest Time
506	Smoke Limiting
507	Smoke Limiting Off
508	Safety On Delay
509	Warm Up Time
510	Return Delay
511	Cooling Time
512	ETS Solenoid Hold
513	Failed To Stop Delay
514	Generator Transient Delay
515	Transfer Time
516	Breaker Trip Pulse
517	Breaker Close Pulse
518	Delayed Load Output 1
519	Delayed Load Output 2
520	Delayed Load Output 3
521	Delayed Load Output 4
522	Power Save Mode Delay
523	Deep Sleep Mode Delay
524	Page Timer
525	Cooling Time at Idle
526	Manual Crank Limit

6.2.6 GENERATOR SETTINGS

Configuration Parameters – Generator (Page 6)		
601	Alternator Fitted	On (1), Off (0)
602	Alternator Poles	0
603	Under Voltage Shutdown Enable	On (1), Off (0)
604	Under Voltage Trip Shutdown	0 V
605	Under Voltage Warning Enable	On (1), Off (0)
606	Under Voltage Warning Trip	0 V
607	RESERVED	
608	Loading Voltage	0 V
609	Over Voltage Warning Enable	On (1), Off (0)
610	Over Voltage Warning Return	0 V
611	Over Voltage Warning Trip	0 V
612	Over Voltage Shutdown Trip	0 V
613	Under Frequency Shutdown Enable	On (1), Off (0)
614	Under Frequency Shutdown Trip	0.0 Hz
615	Under Frequency Warning Enable	On (1), Off (0)
616	Under Frequency Warning Trip	0.0 Hz
617	RESERVED	
618	Loading Frequency	0.0 Hz
619	Nominal Frequency	0.0 Hz
620	Over Frequency Warning Enable	On (1), Off (0)
621	Over Frequency Warning Return	0.0 Hz
622	Over Frequency Warning Trip	0.0 Hz
623	Over Frequency Shutdown Enable	On (1), Off (0)
624	Over Frequency Shutdown Trip	0.0 Hz
625	AC System	0 (Ac System)
626	CT Primary	0 A
627	Full Load Rating	0 A
628	Immediate Over Current Enable	On (1), Off (0)
629	Delayed Over Current Alarm Enable	On (1), Off (0)
630	Delayed Over Current Alarm Action	0 (Action)
631	Over Current Delay Time	0 s
632	Over Current Trip	0 %
633	kW Rating	0 kW
634	Over kW Protection Enable	On (1), Off (0)
635	Over kW Protection Action	0 (Action)
636	Over kW Protection Trip	0 %
637	Over kW Protection Trip Delay	0 s

6.2.7 MAINS SETTINGS

x	Functionality in DSE6010 MKII & DSE6020 MKII
x	Functionality in DSE6020 MKII only

Configuration Parameters – Mains (Page 7)		
701	AC System	0 (AC System)
702	Mains Failure Detection	On (1), Off (0)
703	Immediate Mains Dropout	On (1), Off (0)
704	Under Voltage Enable	On (1), Off (0)
705	Under Voltage Level	0 V
706	Under Voltage Return	0 V
707	Over Voltage Enable	On (1), Off (0)
708	Over Voltage Return	0 V
709	Over Voltage Level Trip	0 V
710	Under Frequency Enable	On (1), Off (0)
711	Under Frequency Trip	0.0 Hz
712	Under Frequency Return	0.0 Hz
713	Over Frequency Enable	On (1), Off (0)
714	Over Frequency Return	0 Hz
715	Over Frequency Trip	0.0 Hz

6.2.8 ENGINE SETTINGS

Configuration Parameters – Engine (Page 8)		
801	Start Attempts	0
802	Over Speed Overshoot	0 %
803	Over Speed Delay	0 s
804	Gas Choke Timer (Gas Engine Only)	0 s
805	Gas On Delay (Gas Engine Only)	0 s
806	Gas Ignition Off Delay (Gas Engine Only)	0 s
807	Crank Disconnect On Oil Pressure Enable	On (1), Off (0)
808	Check Oil Pressure Prior To Starting	On (1), Off (0)
809	Crank Disconnect On Oil	0.00 Bar
810	Crank Disconnect On Frequency	0.0 Hz
811	Crank Disconnect On Engine Speed	0 RPM
812	Under Speed Enable	On (1), Off (0)
813	Under Speed Trip	0 RPM
814	Over Speed Trip	0 RPM
815	Low Battery Voltage Enable	On (1), Off (0)
816	Low Battery Voltage Trip	0.0 V
817	Low Battery Voltage Return	0.0 V
818	Low Battery Voltage Delay	0:00:00
819	High Battery Voltage Enable	On (1), Off (0)
820	High Battery Voltage Return	0.0 V
821	High Battery Voltage Trip	0.0 V
822	High Battery Voltage Warning Delay	0 s
823	Charge Alt Shutdown Enable	On (1), Off (0)
824	Charge Alt Shutdown Trip	0.0 V
825	Charge Alt Shutdown Delay	0 s
826	Charge Alt Warning Enable	On (1), Off (0)
827	Charge Alt Warning Trip	0.0 V
828	Charge Alt Warning Delay	0 s
829	Low Battery Start Arming	On (1), Off (0)
830	Low Battery Start Threshold	0.0 V
831	Low Battery Start Delay	0 s
832	Low Battery Start Run Time	0 s
833	Magnetic Pickup Fitted	On (1), Off (0)
834	Flywheel Teeth	0

6.2.9 ANALOGUE INPUTS SETTINGS

Configuration Parameters – Analogue Inputs (Page 9)		
901	Low Oil Pressure Enable	On (1), Off (0)
902	Low Oil Pressure Trip	0 Bar
903	Oil Pressure Sender Open Circuit	On (1), Off (0)
904	Analogue Input A Sensor Usage	Digital Input (0), Flexible (1), Oil Pressure (3) Sensor
905	Analogue Input A Flexible Sensor Type	0 (Sensor Type)
906	Analogue Input A Sensor Selection	0 (Pressure, Temperature, Percentage Sensor List)
907	Flexible Sensor A Arming	0 (Arming)
908	Flexible Sensor A Low Alarm Action	0 (Action)
909	Flexible Sensor A Low Alarm Trip	0 % / Bar / °C
910	RESERVED	
911	Flexible Sensor A Low Pre-Alarm Enable	On (1), Off (0)
912	Flexible Sensor A Low Pre-Alarm Trip	0 % / Bar / °C
913	Flexible Sensor A Low Pre-Alarm Return	0 % / Bar / °C
914	RESERVED	
915	Flexible Sensor A High Pre-Alarm Enable	On (1), Off (0)
916	Flexible Sensor A High Pre-Alarm Return	0 % / Bar / °C
917	Flexible Sensor A High Pre-Alarm Trip	0 % / Bar / °C
918-919	RESERVED	
920	Flexible Sensor A High Alarm Action	0 (Action)
921	Flexible Sensor A High Alarm Trip	0 % / Bar / °C
922	RESERVED	
923	Analogue Input B Sensor Usage	Digital Input (0), Temperature (2) Sensor
924	Analogue Input B Sensor Selection	0 (Pressure, Temperature, Percentage Sensor List)
925	High Engine Temperature Trip	0.00 °C
926	Temperature Sender Open Circuit	On (1), Off (0)
927	Analogue Input C Sensor Usage	Digital Input (0), Flexible (1), Fuel Level (2) Sensor
928	Analogue Input C Flexible Sensor Type	0 (Sensor Type)
929	Analogue Input C Sensor Selection	0 (Pressure, Temperature, Percentage Sensor List)
930	Flexible Sensor C Arming	0 (Arming)
931	Flexible Sensor C Low Alarm Action	0 (Action)
932	Flexible Sensor C Low Alarm Trip	0 % / Bar / °C
933	RESERVED	
934	Flexible Sensor C Low Pre-Alarm Enable	On (1), Off (0)
935	Flexible Sensor C Low Pre-Alarm Trip	0 % / Bar / °C
936	Flexible Sensor C Low Pre-Alarm Return	0 % / Bar / °C
937	RESERVED	
938	Flexible Sensor C High Pre-Alarm Enable	On (1), Off (0)
939	Flexible Sensor C High Pre-Alarm Return	0 % / Bar / °C
940	Flexible Sensor C High Pre-Alarm Trip	0 % / Bar / °C
941-942	RESERVED	
943	Flexible Sensor C High Alarm Action	0 (Action)
944	Flexible Sensor C High Alarm Trip	0 % / Bar / °C
945-946	RESERVED	
947	Fuel Sensor C Low Shutdown Enable	On (1), Off (0)
948	Fuel Sensor C Low Shutdown Trip	0 %
949	Fuel Sensor C Low Shutdown Delay	0 s
950	Fuel Sensor C Low Pre-Alarm Enable	On (1), Off (0)
951	Fuel Sensor C Low Pre-Alarm Trip	0 %
952	Fuel Sensor C Low Pre-Alarm Return	0 %

Configuration Parameters – Analogue Inputs (Page 9)		
953	Fuel Sensor C Low Pre-Alarm Delay	0 s
954	Fuel Sensor C High Pre-Alarm Enable	On (1), Off (0)
955	Fuel Sensor C High Pre-Alarm Return	0 %
956	Fuel Sensor C High Pre-Alarm Trip	0 %
957	Fuel Sensor C High Pre Alarm Delay	0 s
959	Fuel Sensor C High Alarm Action	0 (Action)
960	Fuel Sensor C High Alarm Trip	0 %
961	Fuel Sensor C High Alarm Delay	0 s
962	Analogue Input D Sensor Usage	Digital Input (0), Flexible (1), Oil Pressure (3) Sensor
963	Analogue Input D Sensor Type	0 (Sensor Type)
964	Analogue Input D Sensor Selection	0 (Pressure / Temperature / Percentage Sensor List)
965	Analogue Input D Sensor Signal	Current (0), Resistive (1), Voltage (2)
966	Flexible Sensor D Arming	0 (Arming)
967	Flexible Sensor D Low Alarm Enable	On (1), Off (0)
968	Flexible Sensor D Low Alarm Trip	0 % / Bar / °C
969	RESERVED	
970	Flexible Sensor D Low Pre-Alarm Enable	On (1), Off (0)
971	Flexible Sensor D Low Pre-Alarm Trip	0 % / Bar / °C
972	Flexible Sensor D Low Pre-Alarm Return	0 % / Bar / °C
973	RESERVED	
974	Flexible Sensor D High Pre-Alarm Enable	On (1), Off (0)
975	Flexible Sensor D High Pre-Alarm Return	0 % / Bar / °C
976	Flexible Sensor D High Pre-Alarm Trip	0 % / Bar / °C
977-978	RESERVED	
979	Flexible Sensor D High Alarm Action	0 (Action)
980	Flexible Sensor D High Alarm Trip	0 % / Bar / °C
981	RESERVED	
982	Fuel Sensor Units	0 (Fuel Sensor Units)
983	Fuel Tank Size	0
984	Fuel Pump Enable	On (1), Off (0)
985	Fuel Pump On Level	0 %
986	Fuel Pump Off Level	0 %

6.2.10 SCHEDULER SETTINGS

Configuration Parameters – Scheduler (Page 10)		
1001	Enable Scheduler	On (1), Off (0)
1002	Schedule Run On or Off Load	On (1), Off (0)
1003	Schedule Period	Weekly (0), Monthly (1)
1004	Scheduler (1) Start Time	0:00:00
1005	Scheduler (1) Start Day	0 (1=Monday)
1006	Scheduler (1) Start Week	1,2,3,4
1007	Scheduler (1) Duration	0:00:00
1008	Scheduler (2) Start Time	0:00:00
1009	Scheduler (2) Start Day	0 (1=Monday)
1010	Scheduler (2) Start Week	1,2,3,4
1011	Scheduler (2) Duration	0:00:00
1012	Scheduler (3) Start Time	0:00:00
1013	Scheduler (3) Start Day	0 (1=Monday)
1014	Scheduler (3) Start Week	1,2,3,4
1015	Scheduler (3) Duration	0:00:00
1016	Scheduler (4) Start Time	0:00:00
1017	Scheduler (4) Start Day	0 (1=Monday)
1018	Scheduler (4) Start Week	1,2,3,4
1019	Scheduler (4) Duration	0:00:00
1020	Scheduler (5) Start Time	0:00:00
1021	Scheduler (5) Start Day	0 (1=Monday)
1022	Scheduler (5) Start Week	1,2,3,4
1023	Scheduler (5) Duration	0:00:00
1024	Scheduler (6) Start Time	0:00:00
1025	Scheduler (6) Start Day	0 (1=Monday)
1026	Scheduler (6) Start Week	1,2,3,4
1027	Scheduler (6) Duration	0:00:00
1028	Scheduler (7) Start Time	0:00:00
1029	Scheduler (7) Start Day	0 (1=Monday)
1030	Scheduler (7) Start Week	1,2,3,4
1031	Scheduler (7) Duration	0:00:00
1032	Scheduler (8) Start Time	0:00:00
1033	Scheduler (8) Start Day	0 (1=Monday)
1034	Scheduler (8) Start Week	1,2,3,4
1035	Scheduler (8) Duration	0:00:00

6.2.11 TIME AND DATE SETTINGS

Configuration Parameters – Time (Page 11)		
1101	Time of Day	0:00:00
1102	Day of Week	0 (1=Monday)
1103	Week of Year	1-52
1104	Day of Month	1-31
1105	Month of Year	1-12
1106	Year	0-99

6.2.12 MAINTENANCE ALARM SETTINGS

Configuration Parameters – Maintenance Alarms (Page 12)		
1201	Oil Maintenance Alarm Enable	On (1), Off (0)
1202	Oil Maintenance Alarm Action	0 (Action)
1203	Oil Maintenance Alarm Engine Hours	0 h
1204	Air Maintenance Alarm Enable	On (1), Off (0)
1205	Air Maintenance Alarm Action	0 (Action)
1206	Air Maintenance Alarm Engine Hours	0 h
1207	Fuel Maintenance Alarm Enable	On (1), Off (0)
1208	Fuel Maintenance Alarm Action	0 (Action)
1209	Fuel Maintenance Alarm Engine Hours	0 h

6.2.13 ALTERNATE CONFIGURATION SETTINGS

Configuration Parameters – Alternate Configuration (Page 20)		
2001	Default Configuration	On (1), Off (0)
2002	Enable Configuration	On (1), Off (0)
2003	CAN Alternative Engine Speed	On (1), Off (0)
2004	Under Voltage Shutdown Enable	On (1), Off (0)
2005	Under Voltage Shutdown Trip	0 V
2006	Under Voltage Warning Enable	On (1), Off (0)
2007	Under Voltage Warning Trip	0 V
2008	Loading Voltage	0 V
2009	Over Voltage Warning Enable	On (1), Off (0)
2010	Over Voltage Warning Return	0 V
2011	Over Voltage Warning Trip	0 V
2012	Over Voltage Trip	0 V
2013	Under Frequency Shutdown Enable	On (1), Off (0)
2014	Under Frequency Shutdown Trip	0.0 Hz
2015	Under Frequency Warning Enable	On (1), Off (0)
2016	Under Frequency Warning Trip	0.0 Hz
2017	Loading Frequency	0.0 Hz
2018	Nominal Frequency	0.0 Hz
2019	Over Frequency Warning Enable	On (1), Off (0)
2020	Over Frequency Warning Return	0.0 Hz
2021	Over Frequency Warning Trip	0.0 Hz
2022	Over Frequency Shutdown Enable	On (1), Off (0)
2023	Over Frequency Shutdown Trip	0.0 Hz

Parameters continued overleaf.

Front Panel Configuration

x	Functionality in DSE6010 MKII & DSE6020 MKII
x	Functionality in DSE6020 MKII only

Configuration Parameters – Alternate Configuration (Page 20)		
2024	CT Primary	0 A
2025	Full Load Rating	0 A
2026	Immediate Over Current	On (1), Off (0)
2027	Delayed Over Current Alarm	On (1), Off (0)
2028	Delayed Over Current Alarm Action	0 (Action)
2029	Over Current Delay	00:00:00
2030	Over Current Trip	0 %
2031	Generator kW Rating	0 kW
2032	Overload Protection Enable	On (1), Off (0)
2033	Overload Protection Action	0 (Action)
2034	Overload Protection Trip	0 %
2035	Overload Protection Trip Delay	0 s
2036	AC System	0 (AC system)
2037	Mains Failure Detection	On (1), Off (0)
2038	Immediate Mains Dropout	On (1), Off (0)
2039	Mains Under Voltage Enable	On (1), Off (0)
2040	Mains Under Voltage Trip	0 V
2041	Mains Under Voltage Return	0 V
2042	Mains Over Voltage Enable	On (1), Off (0)
2043	Mains Over Voltage Return	0 V
2044	Mains Over Voltage Trip	0 V
2045	Mains Under Frequency Enable	On (1), Off (0)
2046	Mains Under Frequency Trip	0.0 Hz
2047	Mains Under Frequency Return	0.0 Hz
2048	Mains Over Frequency Enable	On (1), Off (0)
2049	Mains Over Frequency Return	0.0 Hz
2050	Mains Over Frequency Trip	0.0 Hz
2051	Under Speed Shutdown Enable	On (1), Off (0)
2052	Under Speed Shutdown Trip	0 RPM
2053	Over Speed Shutdown Trip	0 RPM

6.3 SELECTABLE PARAMETER SETTINGS

6.3.1 INPUT SOURCES

x	Functionality in DSE6010 MKII & DSE6020 MKII
x	Functionality in DSE6020 MKII only

Input Sources		
0	User Configured	
1	Alarm Mute	
2	Alarm Reset	
3	Alternative Configuration	
4	Auto Restore Inhibit	
5	Auto Start Inhibit	
6	Auxiliary Mains Fail	
7	Coolant Temperature Switch	
8	Emergency Stop	
9	External Panel Lock	
10	Generator Load Inhibit	
11	Lamp Test	
12	Low Fuel Level Switch	
13	Mains Load Inhibit	
14	Oil Pressure Switch	
15	Remote Start Off Load	
16	Remote Start On Load	
17	Simulate Mains Available	
18	Simulate Stop Button	
19	Simulate Auto Button	
20	Simulate Start Button	
21	Smoke Limiting	
22	Close Generator	Open Mains
23	Close Mains	Open Generator
24	Maintenance Reset Oil	
25	Maintenance Reset Air	
26	Maintenance Reset Fuel	
27	Simulate Manual Button	
28	Simulate Test Button	
29	Manual Mode And Start Request	

6.3.2 OUTPUT SOURCES

x	Functionality in DSE6010 MKII & DSE6020 MKII
x	Functionality in DSE6020 MKII only

Output Sources	
0	Not Used
1	Air Flap Relay
2	Audible Alarm
3	Battery Over Volts Warning
4	Battery Under Volts Warning
5	CAN ECU Data Fail
6	CAN ECU Error
7	CAN ECU Fail
8	CAN ECU Power
9	CAN ECU Stop
10	Charge Alternator Shutdown
11	Charge Alternator Warning
12	Close Gen Output
13	Close Gen Output Pulse
14	Close Mains Output
15	Close Mains Output Pulse
16	Combined Mains Failure
17	Common Alarm
18	Common Electrical Trip
19	Common Shutdown
20	Common Warning
21	Cooling Down
22	Digital Input A
23	Digital Input B
24	Digital Input C
25	Digital Input D
26	Digital Input E
27	Digital Input F
28	RESERVED
29	Emergency Stop
30	Energise To Stop
31	Fail To Start
32	Fail To Stop
33	Fuel Relay
34	Gas Choke On
35	Gas Ignition
36	Generator Available
37	Generator Over Voltage Shutdown
38	Generator Under Voltage Shutdown
39	kW Overload Alarm
40	Over Current Immediate Warning
41	Delayed Over Current Trip Alarm
42	High Coolant Temperature Shutdown
43	Low Oil Pressure Shutdown
44	Mains High Frequency
45	Mains High Voltage
46	Mains Low Frequency
47	Mains Low Voltage

Output sources continued overleaf.

Front Panel Configuration

x	Functionality in DSE6010 MKII & DSE6020 MKII
x	Functionality in DSE6020 MKII only

Output Sources	
48	Oil Pressure Sender Open Circuit
49	Open Gen Output
50	Open Gen Output Pulse
51	Open Mains Output
52	Open Mains Output Pulse
53	Over Frequency Shutdown
54	Over Speed Shutdown
55	Preheat During Preheat Timer
56	Preheat Until End Of Crank
57	Preheat Until End Of Safety Timer
58	Preheat Until End Of Warming
59	Smoke Limiting
60	Start Relay
61	Temperature Sender Open Circuit
62	Under Frequency Shutdown
63	Under Speed Shutdown
64	Flexible Sender A High Alarm
65	Flexible Sender A High Alarm
66	Flexible Sender A Low Pre-Alarm
67	Flexible Sender A Low Alarm
68	Waiting For Manual Restore
69	Flexible Sender C High Alarm
70	Flexible Sender C High Alarm
71	Flexible Sender C Low Pre-Alarm
72	Flexible Sender C Low Alarm
73	Flexible Sender D High Alarm
74	Flexible Sender D High Alarm
75	Flexible Sender D Low Pre-Alarm
76	Flexible Sender D Low Alarm
77	Fuel Sender High Alarm
78	Fuel Sender High Alarm
79	Fuel Sender Low Pre-Alarm
80	Fuel Sender Low Alarm
81	Delayed Load Output 1
82	Delayed Load Output 2
83	Delayed Load Output 3
84	Delayed Load Output 4
85	Air Filter Maintenance Output
86	Oil Filter Maintenance Output
87	Fuel Filter Maintenance Output
88	System In Stop Mode
89	System In Auto Mode
90	System In Manual Mode
91	Fuel Pump Control
92	Analogue Input A (Digital)
93	Analogue Input B (Digital)
94	Analogue Input C (Digital)
95	Analogue Input D (Digital)
96	System In Test Mode
97	Loss Of MPU Signal
98	MPU Open Circuit
99	Over Speed Overshoot
100	Over Frequency Overshoot
101	Display Heater Fitted and Active

6.3.3 ALARM ACTION

Alarm Action	
Index	Action
0	Electrical Trip
1	Shutdown
2	Warning

6.3.4 FLEXIBLE SENSOR ALARM ACTION

Flexible Sensor Alarm Action	
Index	Action
0	None
1	Shutdown
2	Electrical Trip

6.3.5 POWER UP MODE

Power Up Mode	
Index	Mode
0	Stop
1	Manual
2	Auto

6.3.6 SENSOR TYPE

Sensor Type	
Index	Type
0	None
1	Digital Input
2	Percentage Sensor
3	Pressure Sensor
4	Temperature Sensor

6.3.7 AC SYSTEM

AC System	
Index	Type
0	2 Phase 3 Wire (L1-L2)
1	2 Phase 3 Wire (L1-L3)
2	3 Phase 3 Wire
3	3 Phase 4 Wire
4	3 Phase 4 Wire (Delta)
5	Single Phase 2 Wire

6.3.8 DIGITAL INPUT ALARM ARMING

Digital Input Alarm Arming	
Index	Arming
0	Always
1	From Safety On
2	From Starting
3	Never

6.3.9 DIGITAL INPUT POLARITY

Digital Input Polarity	
Index	Polarity
0	Close to Activate
1	Open to Activate

6.3.10 DIGITAL OUTPUT POLARITY

Output Polarity	
Index	Polarity
0	Energise
1	De-Energise

6.3.11 FUEL UNITS

Fuel Units	
Index	Units
0	Litres
1	Imperial Gallons
2	US Gallons

6.3.12 PRESSURE SENSOR LIST

Pressure Sensor List	
Index	Type
0	Not used
1	Dig Closed for Alarm
2	Dig Open for Alarm
3	VDO 5 Bar
4	VDO 10 Bar
5	Datcon 5 Bar
6	Datcon 10 Bar
7	Datcon 7 Bar
8	Murphy 7 Bar
9	CMB812
10	Veglia
11	User Defined

6.3.13 TEMPERATURE SENSOR LIST

Temperature Sensor List	
Index	Type
0	Not Used
1	Dig Closed for Alarm
2	Dig Open for Alarm
3	VDO 120 °C
4	Datcon High
5	Datcon Low
6	Murphy
7	Cummins
8	PT100
9	Veglia
10	Beru
11	User Defined







6.3.14 PERCENTAGE SENSOR LIST

Percentage Sensor List	
Index	Type
0	Not Used
1	Dig Closed for Alarm
2	Dig Open for Alarm
3	VDO Ohm (10-180)
4	VDO Tube (90-0)
5	US Ohm (240-33)
6	GM Ohm (0-90)
7	GM Ohm (0-30)
8	Ford (73-10)
9	User Defined

7 COMMISSIONING

 **NOTE: If Emergency Stop feature is not required, link the input to the DC Positive.**

Before the system is started, it is recommended that the following checks are made:-

- The unit is adequately cooled and all the wiring to the module is of a standard and rating compatible with the system. Check all mechanical parts are fitted correctly and that all electrical connections (including earths) are sound.
- The unit DC supply is fused and connected to the battery and that it is of the correct polarity.
- The Emergency Stop input is wired to an external normally closed switch connected to DC positive.
- To check the start cycle operation, take appropriate measures to prevent the engine from starting (disable the operation of the fuel solenoid). After a visual inspection to ensure it is safe to proceed, connect the battery supply. Press the *Manual Mode*  button followed by the *Start*  button the unit start sequence commences.
- The starter engages and operates for the pre-set crank period. After the starter motor has attempted to start the engine for the pre-set number of attempts, the LCD displays 'Failed to start'. Press the *Stop/Reset Mode*  button to reset the unit.
- Restore the engine to operational status (reconnect the fuel solenoid). Press the *Manual Mode*  button followed by the *Start*  button. This time the engine should start and the starter motor should disengage automatically. If not then check that the engine is fully operational (fuel available, etc.) and that the fuel solenoid is operating. The engine should now run up to operating speed. If not, and an alarm is present, check the alarm condition for validity, then check input wiring. The engine should continue to run for an indefinite period. It is possible at this time to view the engine and alternator parameters - refer to the 'Description of Controls' section of this manual.
- Press the *Auto Mode*  button, the engine runs for the pre-set cooling down period, then stop. The generator should stay in the standby mode. If not check that there is not a signal present on the Remote start input.
- Initiate an automatic start by supplying the remote start signal (if configured). The start sequence commences and the engine runs up to operational speed. Once the generator is available the delayed load outputs activate, the Generator accepts the load. If not, check the wiring to the delayed load output contactors. Check the Warming timer has timed out.
- Remove the remote start signal. The return sequence begins. After the pre-set time, the generator is unloaded. The generator then runs for the pre-set cooling down period, then shutdown into its standby mode.
- Set the modules internal clock/calendar to ensure correct operation of the scheduler and event logging functions. For details of this procedure see section entitled *Front Panel Configuration*
- If, despite repeated checking of the connections between the controller and the customer's system, satisfactory operation cannot be achieved, then the customer is requested to the DSE Technical Support Department

8 FAULT FINDING

8.1 STARTING

Symptom	Possible Remedy
Unit is inoperative Read/Write configuration does not operate	Check the battery and wiring to the unit. Check the DC supply. Check the DC fuse.
Unit shuts down	Check DC supply voltage is not above 35 Volts or below 9 Volts Check the operating temperature is not above 70°C. Check the DC fuse.
Fail to Start is activated after pre-set number of attempts to start	Check wiring of fuel solenoid. Check fuel. Check battery supply. Check battery supply is present on the Fuel output of the module. Check the speed-sensing signal is present on the module's inputs. Refer to engine manual.
Continuous starting of generator when in the <i>Auto Mode</i> 	Check that there is no signal present on the "Remote Start" input. Check configured polarity is correct. Check the mains supply is available and within configured limits
Generator fails to start on receipt of Remote Start signal.	Check Start Delay timer has timed out. Check signal is on "Remote Start" input. Confirm correct configuration of input is configured to be used as "Remote Start". Check that the oil pressure switch or sensor is indicating low oil pressure to the controller. Depending upon configuration, the set does not start if oil pressure is not low.
Pre-heat inoperative	Check wiring to engine heater plugs. Check battery supply. Check battery supply is present on the Pre-heat output of module. Check pre-heat configuration is correct.
Starter motor inoperative	Check wiring to starter solenoid. Check battery supply. Check battery supply is present on the Starter output of module. Ensure oil pressure switch or sensor is indicating the "low oil pressure" state to the controller.

8.2 LOADING

Symptom	Possible Remedy
Engine runs but generator does not take load	Check Warm up timer has timed out. Ensure generator load inhibit signal is not present on the module inputs. Check connections to the switching device. Note that the set does not take load in <i>Manual Mode</i>  unless there is an active load signal.
Incorrect reading on Engine gauges Fail to stop alarm when engine is at rest	Check engine is operating correctly. Check that sensor is compatible with the module and that the module configuration is suited to the sensor.

8.3 ALARMS

Symptom	Possible Remedy
Low oil Pressure fault operates after engine has fired	Check engine oil pressure. Check oil pressure switch/sensor and wiring. Check configured polarity (if applicable) is correct (i.e. Normally Open or Normally Closed) or that sensor is compatible with the module and is correctly configured.
High engine temperature fault operates after engine has fired.	Check engine temperature. Check switch/sensor and wiring. Check configured polarity (if applicable) is correct (i.e. Normally Open or Normally Closed) or that sensor is compatible with the module.
Shutdown fault operates	Check relevant switch and wiring of fault indicated on LCD display. Check configuration of input.
Electrical Trip fault operates	Check relevant switch and wiring of fault indicated on LCD display. Check configuration of input.
Warning fault operates	Check relevant switch and wiring of fault indicated on LCD display. Check configuration of input.
CAN ECU WARNING CAN ECU SHUTDOWN	This indicates a fault condition detected by the engine ECU and transmitted to the DSE controller.
CAN DATA FAIL	Indicates failure of the CAN data link to the engine ECU. Check all wiring and termination resistors (if required).
Incorrect reading on Engine gauges	Check engine is operating correctly. Check sensor and wiring paying particular attention to the wiring to terminal 10 (refer to appendix).
Fail to stop alarm when engine is at rest	Check that sensor is compatible with the module and that the module configuration is suited to the sensor.

8.4 COMMUNICATIONS

Symptom	Possible Remedy
CAN DATA FAIL	Indicates failure of the CAN data link to the engine ECU. Check all wiring and termination resistors (if required).

8.5 INSTRUMENTS

Symptom	Possible Remedy
Inaccurate generator measurements on controller display	<p>Check that the CT primary, CT secondary and VT ratio settings are correct for the application.</p> <p>Check that the CTs are wired correctly with regards to the direction of current flow (p1,p2 and s1,s2) and additionally ensure that CTs are connected to the correct phase (errors occur if CT1 is connected to phase 2).</p> <p>Remember to consider the power factor ($kW = kVA \times \text{powerfactor}$).</p> <p>The controller is true RMS measuring so gives more accurate display when compared with an 'averaging' meter such as an analogue panel meter or some lower specified digital multimeters.</p> <p>Accuracy of the controller is better than 1% of full scale. Generator voltage full scale is 415 V ph-N, accuracy is ± 4.15 V (1 % of 415 V).</p>

8.6 MISCELLANEOUS

 **NOTE:** The above fault finding is provided as a guide check-list only. As the module can be configured to provide a wide range of different features, always refer to the source of your module configuration if in doubt.

Symptom	Possible Remedy
Module appears to 'revert' to an earlier configuration	<p>When editing a configuration using the PC software it is vital that the configuration is first 'read' from the controller before editing it. This edited configuration must then be "written" back to the controller for the changes to take effect.</p> <p>When editing a configuration using the fascia editor, be sure to press the the Auto Mode  (✓) button to save the change before moving to another item or exiting the fascia editor</p>

9 MAINTENANCE, SPARES, REPAIR AND SERVICING

The controller is *Fit and Forget*. As such, there are no user serviceable parts within the controller. In the case of malfunction, you should contact your original equipment manufacturer (OEM).







9.1 PURCHASING ADDITIONAL CONNECTOR PLUGS FROM DSE

If you require additional plugs from DSE, please contact our Sales department using the part numbers below.

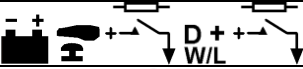
9.1.1 PACK OF PLUGS

Module Type	Plug Pack Part Number
DSE6010 MKII	100-400-69
DSE6020 MKII	100-400-66

9.1.2 INDIVIDUAL PLUGS

Module Terminal Designation	Plug Description	Part No.
1-10 	10 way 5.08 mm	007-450
11-21 	11 way 5.08 mm	007-451
25-28  DSE6010 MKII Only	4 way 7.62 mm	007-171
25-32  DSE6020 MKII Only	8 way 7.62 mm	007-454
33-37 	5 way 5.08 mm	007-445
38-43 	6 way 5.08 mm	007-446
 USB	PC Configuration interface lead (USB type A – USB type B)	016-125

9.2 PURCHASING ADDITIONAL FIXING CLIPS FROM DSE

Item	Description	Part No.
	Module Fixing Clips (Packet Of 2)	020-406

9.3 PURCHASING ADDITIONAL SEALING GASKET FROM DSE

Item	Description	Part No.
	Module Silicon Sealing Gasket	020-521

10 WARRANTY

DSE Provides limited warranty to the equipment purchaser at the point of sale. For full details of any applicable warranty, you are referred to our original equipment supplier (OEM)

11 DISPOSAL

11.1 WEEE (WASTE ELECTRICAL AND ELECTRONIC EQUIPMENT)

If you use electrical and electronic equipment you must store, collect, treat, recycle and dispose of WEEE separately from your other waste.



This Page is Intentionally Left Blank

This Page is Intentionally Left Blank