

**InteliMains  
NTCBaseBox**

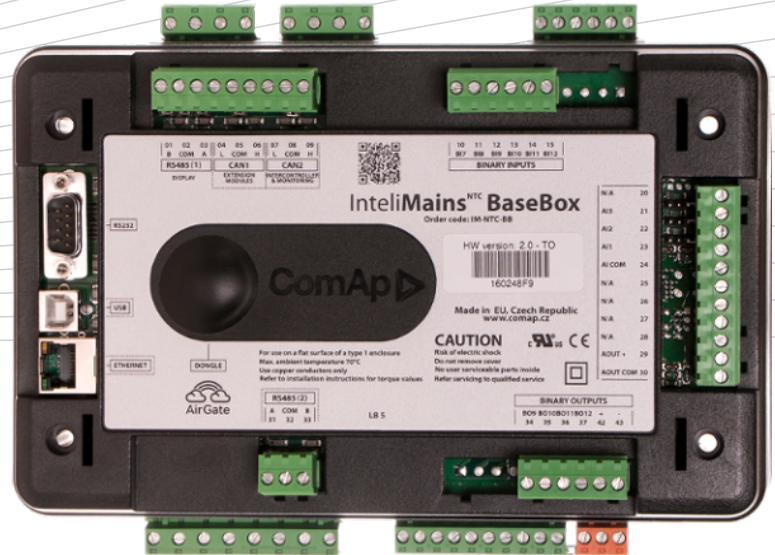

Order code: IM-NTC-BB

**Comprehensive switchgear controller**

**Datasheet**

**Product description**

- ▶ Comprehensive switchgear controller
- ▶ Built-in control for up to 32 logic groups divided by Bus Tie Breakers
- ▶ High level control for complex systems

**Key features**

- ▶ Built-in breaker control
- ▶ Genset group synchronization, Loadsharring and VARsharring via CAN2
- ▶ Customizable load control in parallel to mains
- ▶ Extended communication capabilities
  - Airgate support and more
- ▶ Highly configurable
  - Timers, internal PLC, Force value and more
- ▶ Compatible with ComAp's InteliVision displays
- ▶ Monitoring and configuration with ComAp's PC tools
- ▶ Extensive built-in protection functions
  - Undervoltage, overvoltage
  - Underfrequency, overfrequency and more
- ▶ Full Modbus slave support (RS232)
- ▶ Extendable with ComAp's extension modules

- ▶ True RMS (TRMS) is used with Voltage, Current and Power measurement

**Application overview**

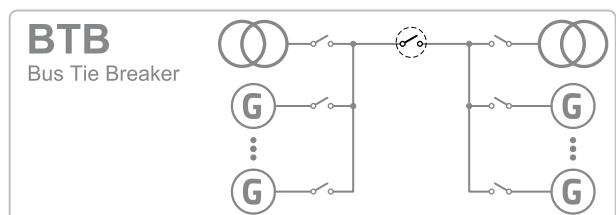
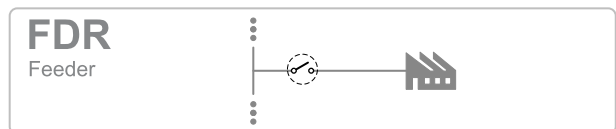
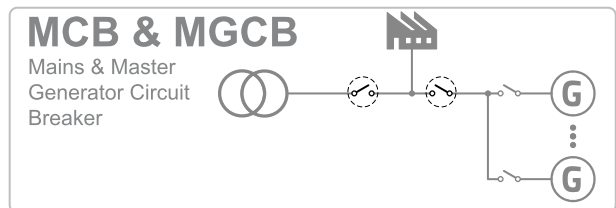
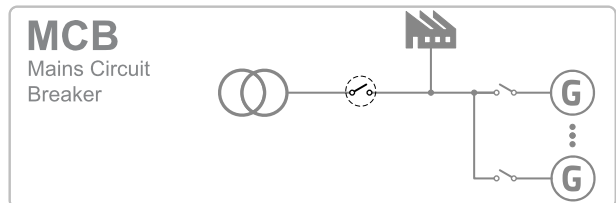

## Technical data

### Power supply

Power supply range	8-36 V DC
Power consumption	0.4 A / 8 VDC 0.15 A / 24 VDC 0.1 A / 36 VDC
RTC battery	10 years (replacable by official service)
Fusing	2 A (without BOUT consumption)
Max. Power Dissipation	16 W

### Operating conditions

Operating temperature	-30 °C to +70 °C
Storage temperature	-40 °C to +80 °C
Max. operating altitude	2000 m above sea level for max 480 V 4000 m above sea level for max 400 V
Operating humidity	95 % non-condensing (EN 60068-2-30)
Vibration	5-25 Hz, $\pm 1.6$ mm 25-100 Hz, a = 4 g
Shocks	a=200m/s <sup>2</sup>
Heat radiation	16 W

### Voltage measurement

Measurement inputs	3 ph-n Mains voltage 3ph-n Bus voltage
Measurement range	110 V / 277 V
Max allowed voltage	125 % ph-n
Accuracy	1 % of 110 V / 277 V
Frequency range	40-70 Hz (at accuracy 0.1 Hz)
Input impedance	0.6 M $\Omega$ ph-ph, 0.3 M $\Omega$ ph-n

### Current measurement

Measurement inputs	3 ph-n Mains voltage 1ph Bus current galvanically isolated
Measurement range	1 A / 5 A
Max allowed current	200 % / 200 %
Accuracy	2 % of 1 A / 5 A
Input impedance	< 0.1 $\Omega$

### Binary inputs

Number	12, non-isolated
Input resistance	4.7 k $\Omega$
Close/Open indication	0-2 V DC close contact >4 V DC open contact

### Binary outputs

Number	12, non-isolated
Max current	0.5 A (2 A per group) group1: BO1-8; group2: BO9-12
Switching to	Negative/positive supply terminal

### Analog inputs

Number	3, non-isolated
Type	Switchable (Voltage, Resistance, Current)
Resolution	10 bits, max 4 decimals
Range	0-5 V DC / 0-2500 $\Omega$ / 0-20 mA
Input impedance	>100 k $\Omega$ / >100 k $\Omega$ / 180 $\Omega$
Accuracy	$\pm 1$ % of meas. value $\pm 5$ mV $\pm 2$ % of meas value $\pm 2$ $\Omega$ $\pm 1$ % of meas value $\pm 0.5$ mA

### Analog outputs

Number	1
Type	Switchable (Voltage, Current)
Range	0-10 V DC / 0-20 mA
Max current/load	5 mA / 500 $\Omega$
Accuracy	$\pm 0.5$ % of output value $\pm 20$ mV $\pm 0.5$ % of output value $\pm 100$ $\mu$ A

### Communications

RS232	Direct / Modbus, non-isolated
RS485	Direct / Modbus, isolated
Display port	Non-isolated RS485, direct/modbus/terminal connection
USB port	Direct, Isolated
Ethernet port	galvanically isolated LAN / Internet, Modbus TCP, Airgate
CAN1	External modules, 250kbps, max 200 m, Isolated
CAN2	Intercontroller and comm extensions 250 / 50 kbps, max 200 / 1000 m, Isolated

## Dimensions, terminals and mounting

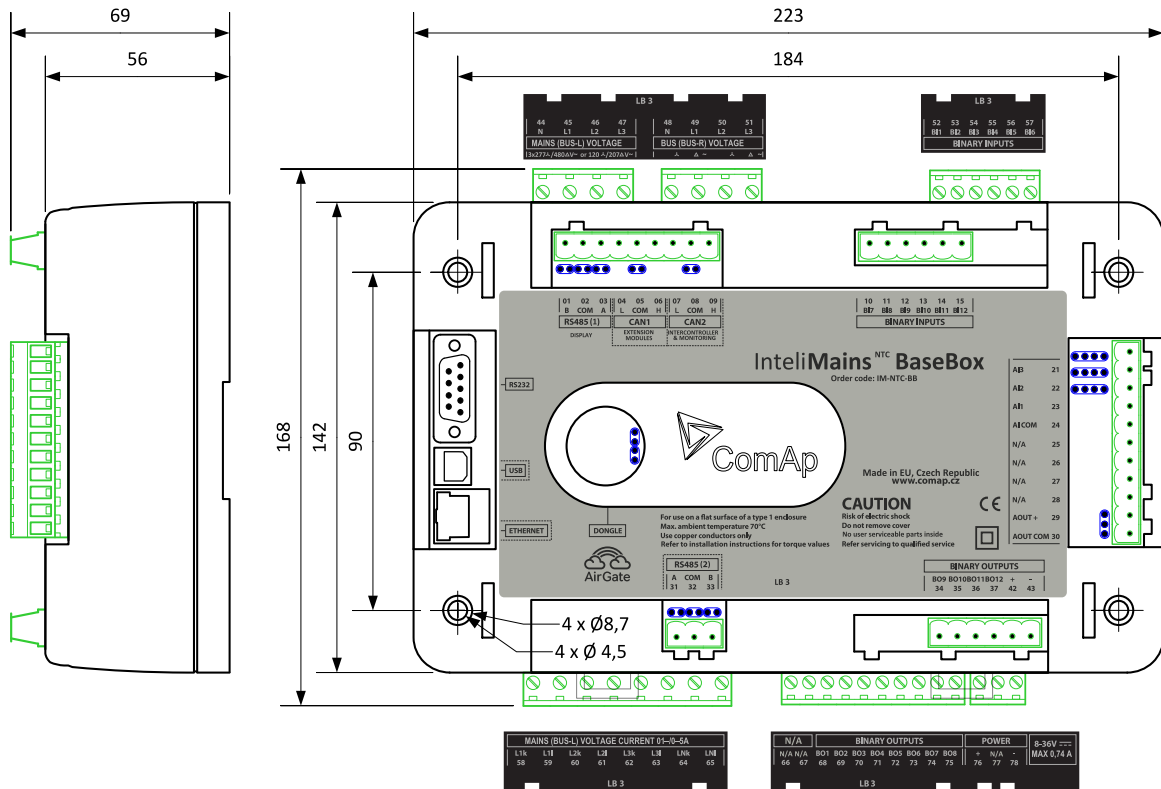

### Panel door mounting with IntelliVision 5

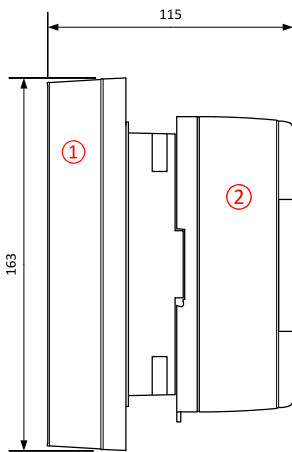

### DIN-rail mounting

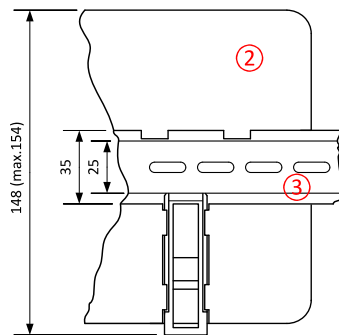

- ① IntelliVision5
- ② IntelliMains<sup>NTC</sup> BaseBox
- ③ DIN-rail
- ④ IntelliVision 8

### Panel door mounting with IntelliVision 8

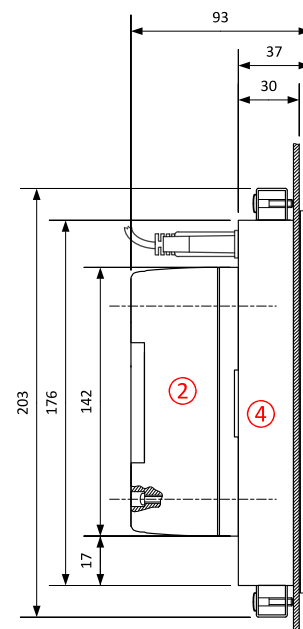

**Note:** IntelliMains<sup>NTC</sup> BaseBox can be mounted on a standard DIN rail or, in combination with IntelliVision 5 or IntelliVision 8, it can be door mounted. IntelliVision 5 features mounting rail for direct mounting. Mounting in combination with IntelliVision 8 uses four screws provided in the IntelliMains<sup>NTC</sup> BaseBox package.

## Available extension modules

Product	Description	Order code
Inteli IO8/8	8 Binary inputs and 8 Binary outputs packed in a small unit (HW switchable to IO16/0)	<a href="#">I-IO8/8</a>
Inteli IO16/0	16 Binary inputs packed in a small unit (HW switchable to IO8/8)	<a href="#">I-IO8/8</a>
Inteli AIN8	8 Analog inputs and 1 pulse/frequency input in a small unit	<a href="#">I-AIN8</a>
InteliAIN8TC	8 Thermocouple Analog inputs in a small unit	<a href="#">I-AIN8TC</a>
IS-AIN8	8 Analog inputs packed in a rugged metal unit	<a href="#">IS-AIN8</a>
IGS-PTM	8 Binary inputs, 8 Binary outputs, 4 Analog inputs and 1 Analog output in a unit	<a href="#">IGS-PTM</a>
IGL-RA15	15 Binary LED output (3 colors) packed in a rugged metal unit	<a href="#">IGL-RA15</a>
I-AOUT8	8 Analog outputs packed in a rugged metal unit	<a href="#">I-AOUT8</a>
InternetBridge-NT	Multiple Internet connections (PC and Modbus) to all controllers on CAN2 or RS485	<a href="#">IB-NT</a>
I-LB+	Direct connection (PC) to all controllers on CAN2 or RS485	<a href="#">I-LB+</a>

## Related products

Product	Description	Order code
InteliVision 5	Color 5.6" display for monitoring and control	<a href="#">INTELVISION 5</a>
InteliVision 5 RD	Color 5.6" display for monitoring and control (RS485 isolated and backlit buttons)	<a href="#">INTELVISION 5 RD</a>
InteliVision 8	Color 8" display for advanced monitoring, control & trending, USB capable	<a href="#">INTELVISION 8</a>
InteliVision17T	Color 17" display for complete monitoring and control of multiple controllers	<a href="#">INTELVISION 17T</a>

## Functions and protections

Support of functions and protections as defined by ANSI (American National Standards Institute):

Description	ANSI code	Description	ANSI code
Master unit	1	Overcurrent IDMT	51
Multi-function device	11	AC circuit breaker	52
Synchronizing-check	25	Overvoltage	59
Undervoltage	27	Alarm relay**	74
Annunciator	30	Vector shift	78
Overload(real power)	32P	Reclosing relay	79
Reverse power	32R	Overfrequency	81O
Current unbalance	46	Underfrequency	81U
Voltage unbalance	47	ROCOF	81R
Overcurrent	50/50TD	Auto selective control/transfer	83
Earth fault*	50G	Regulating device	90

\*Extension module EM-BIO8-EFCP required

\*\*Extension module IGL-RA15 required

## Certificates and standards

▶ EN 60068-2-6 ed.2:2008	▶ IEC 60255-21-1	▶ IEC 60255-22-4	
▶ EN 60068-2-27 ed.2:2010	▶ IEC 60255-21-2	▶ IEC 60255-22-5	
▶ EN 60068-2-30:2005	▶ IEC 60255-11	▶ IEC 60255-22-6	
25/55°C, RH 95%, 48hours	▶ IEC 60255-22-1	▶ IEC 60255-25	
▶ EN 60068-2-64	▶ IEC 60255-22-2	▶ IEC 60255-5	
▶ EN 61010-1:2003	▶ IEC 60255-22-3		
List of standards is available on: <a href="https://webstore.iec.ch/">https://webstore.iec.ch/</a>			

