

GTR-101 Manual

1. Feature

- LCD Screen shows : Over Speed 、 High Water Temperature 、 Low Oil Pressure 、 Over Crank 、 Low Battery Volt.
- Mode Button includes : Off 、 Auto 、 Manual 、 Clear 、 Info and Setup
- Values displayed on LCD : Run Hour 、 Frequency and Battery Volt



- Directly setup from the friendly control panel.
- Wide adjustable working Volt from DC 8 V to 36 V.
- Use the Terminal with high secure and easy install
- Low power consumption 100 mA@12V ; 50 mA@24V
- LCD present clear system status with two color back light

2. Introduction

GTR-101, the compact type digital Gen-set controller, can real-time display the fault message and the immediate status of Gen-set. When the system fault of Gen-set occurs, it can be showed from the indication LED and LCD to inform the maintenance. In setup mode, can adjust the setup value of parameter to suiting with your Gen-set feature.

3. Specification





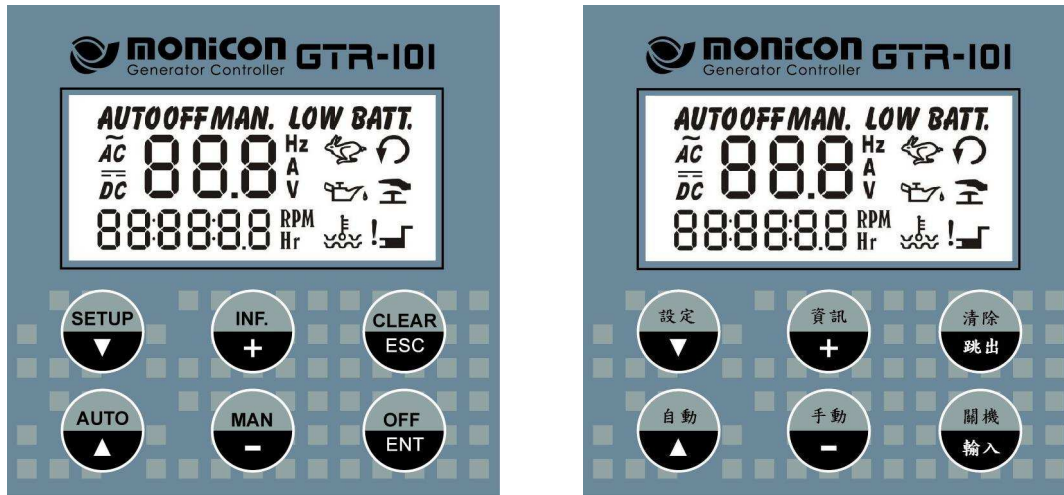

- DC Work Volt
8~36 V (DC)
- Power Consumption
Max. 5 W, 100 mA @ 12 V; 50mA @ 24 V
- Measured Frequency
Minimum measurable volt : 5 V (AC)
Range : 0~80 Hz
- DC Volt Gauge
Range : 10~31 V
- Relay Output
5 A / 30V
- Work Temperature
-30 °C ~70 °C
- Size
72 mm × 72 mm × 58 mm
- Punch Size
68 mm × 68 mm
- Weight
175 g (0.38lb)

4. Control Panel Description

4.1 Panel Outlook



4.2 LCD Icon Descriptions

Icon	Descriptions	Icon	Descriptions
	Emergency Stop	<i>LOWBATT</i>	Low Battery Volt
	High Water Temp.	DC	DC System
	Low Oil Pressure	V	Volt Unit
	Crank Failure	Hr	Run Hour
	Over Speed	Hz	Frequency Unit
	Run	SAVE	Parameter Store
AUTO	Auto Mode	UP_L	Parameter Up-load
OFF	Off	bt_L	Parameter Under -Load
MAN.	Manual Mode	PARA	Parameter Number

4.3 Display Information

4.3.1 Battery Volt

4.3.2 AC Frequency

4.3.5 Run Hour

4.4 Button Function



- a. In standby mode, push it to shift the mode of Run and Code.
- b. In setup mode, push it as the shifting button of information page. (Down)



- a. In code mode, push it to enter the code #1
- b. In standby mode, push it to automatically start the Gen-set.
- c. In setup mode, push it as the shifting button of information page. (UP)



- a. In code mode, push it to enter the code #2
- b. Push it can shift the relative information of Gen-set. The display order: Battery Volt↔Frequency.
- c. In setup mode, push it to increase one unit value of current parameter. (Increase)



- a. In code mode, push it to enter the code #3
- b. In standby mode, push it to manual start Gen-set.
- c. In setup mode, push it to decrease one unit value of current parameter. (Decrease)













- a. In faulty stop status, push it to clear the fault signal.
- b. In setup mode, push this button to exit setup page and cancel current parameter setting.



- a. In code mode, this button is Enter button.
- b. In run status, it can enable the stop function.
- c. In Setup mode, push down this button to save the current setup of user.

5. Panel Operation

- 5.1. Wire the wiring accurately according Monicon manual.
- 5.2. Plug on the DC power to battery. Then all the icon of LCD will light up. User can test the function of LCD.
- 5.3. Once the controller opened, the system mode is under Auto. The Info page will show the battery volt and the run hours.
- 5.4. Push  button to shift the system mode. The order is running operation and code setting.
- 5.5. In **【OFF】** mode, the controller only accept user push  button to start Gen-set. In this mode, the crank time function will off.
- 5.6. After Gen-set run successfully, push  can stop the Gen-set.
- 5.7. In code mode, key in the code 101 and push . After those procedures, the code mode shift to setup mode.
- 5.8. Push  and  to shift parameter page. Push  and  to up or down the setting value. Push  will save the setup parameter. Push  to quit current setup.

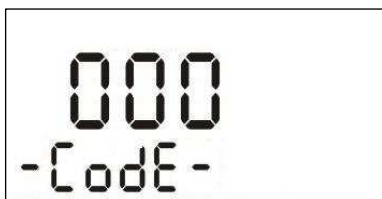

Code Mode Display

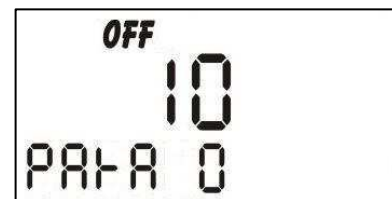

Parameter Setup Display

6. Parameter Setup

6.1. PARA 0 Stop Time OFF

Time : 5~40 Sec

Default : 10 Sec

Parameter explanation : Setup the time of engine shut down and the interval of crank

6.2. PARA 1 Preheat Time

Time : 0~10 Sec

Default : 0 Sec

Parameter explanation : Preheat time before engine start

6.3. PARA 2 Crank Account

Frequency : 1~9 Times

Default : 3 Times

Parameter explanation : Setup the account of Gen-set crank

6.4. PARA 3 Shut Down Time

Time : 0~1250 Sec (Setting Value 0~250 , The base value of Idle time is 5)

Default : 0 (Example : Setting Value 1 , 1*5 = 5 Sec)

Parameter explanation : Setup the cooling down time of engine. (At faulty situation or manual stop, this parameter disables.)

6.5. PARA 4 Idle Time

Time : 0~1250 Sec (Setting Value 0~250 , The base value of Idle time is 5)

Default : 0 (例 : Setting Value 1 , 1*5 = 5 Sec)

Parameter explanation : Setup the Idle speed time of engine

6.6. PARA 5 Low Battery Volt LOWBATT

Range : 9~32 V

Default : 11 V

Parameter explanation : Setup the lower limit of battery volt. As battery volt under the standard, controller occur the alarm of low battery volt.

6.7. PARA 6 Over Speed

Range : 48~70 Hz

Default : 55 Hz

Parameter explanation : Setup the supremum of frequency. If the frequency of Gen-set surpasses the upper limit, controller orders the Gen-set to stop and produce the fault of over speed.

6.8. PARA 7 Function Selection

Range : 0~31

Default : 15

Parameter explanation : According demand to select the function of system

	Disconnect motor by oil pressure build up	Emergency Stop	Low Oil Pressure	High Water Temperature	Over Speed	Result
Example	16	8	4	2	1	
Disconnect motor by oil pressure build up Disable	0	1	1	1	1	15
Emergency Stop Disable	1	0	1	1	1	23
Low Oil Pressure Disable	1	1	0	1	1	27
High Temperature Disable	1	1	1	0	1	29
Over Speed Disable	1	1	1	1	0	30

☒ Note 1 : Above list, 1 present **【enable】**, 0 present **【disable】**

☒ Note 2 : Math method: multiply the corresponding bit of setup value and the weight first, and then add all bits totally.

☒ Example : The disable value of over speed protection and emergency stop protection is:
 $16 * 1 + 8 * 0 + 4 * 1 + 2 * 1 + 1 * 0 = 22$

6.9. PPRR 8 **Circuit Close floor**

Frequency : 42~61 Hz

Default : 45 Hz

Parameter explanation : Setup the lower limit of frequency. Once the frequency under this value, controller will not trigger the signal of load circuit close.

6.10. PPRR 9 **Input Switch type setup**

Value Range : 0~7

Default : 5

Parameter explanation : According the demand to select the type of input switch

High Temperature Switch (4)	Emergency Stop Switch (2)	Low Oil Pressure Switch (1)	Value
N/C	N/C	N/O	0
N/C	N/C	N/C	1
N/C	N/O	N/O	2
N/C	N/O	N/C	3
N/O	N/C	N/O	4
N/O	N/C	N/C	5
N/O	N/O	N/O	6
N/O	N/O	N/C	7

6.11. PPRR R Time Delay of Oil Pressure Switch 

Time : 0.4~6 Sec (Setting Value 2~30 , The base value of delay time is 0.2)

Default : 1.2 Sec (Setting Value 6 , $6 \times 0.2 = 1.2$ Sec)

Parameter explanation : Once setup “disconnect motor by oil pressure built up” as current system setup, if the start procedure be activated, the delay timer will be trigger. In other word, when oil pressure build-up timer is time out and the oil pressure build up successfully, the controller will order starter motor disconnect with engine. This parameter is unconcerned with the faulty delay time of low oil pressure.

6.12. PPRR h RELAY 0 Output function selection

Value Range : 0~5

Default : 4 (Preheat)

Parameter explanation : User can select the output function of REALY 0

(0 : Alarm , 1 : Trip , 2 : Stop , 3 : Circuit Close , **4 : Preheat** , 5 : Idle)

6.13. PPRR [RELAY 1 Output function selection

Value Range : 0~5

Default : 2 (Stop)

Parameter explanation : User can select the output function of REALY 1

(0 : Alarm , 1 : Trip , **2 : Stop** , 3 : Circuit Close , 4 : Preheat , 5 : Idle)

6.14. PPRR d RELAY 2 Output function selection

Range : 0~5

Default : 0 (Alarm)

Parameter explanation : User can select the output function of REALY 2

(**0 : Alarm** , 1 : Trip , 2 : Stop , 3 : Circuit Close , 4 : Preheat , 5 : Idle)

7. System Parameter

- 7.1. Trigger Delay of Emergency Stop : 0.1 Sec / Action : Stop
- 7.2. Trigger Delay of over speed : 2 Sec / Action : Stop
- 7.3. Trigger Delay of High Temperature : 1 Sec / Action : Stop
- 7.4. Trigger Delay of Low Oil Pressure : 1 Sec / Action : Stop
- 7.5. Trigger Delay of Low Battery Volt : 5 Sec / Action : Alarm
- 7.6. Trigger Delay of Circuit Close : 5 Sec (5 second after the Gen-set start normally, contactor will close 1 second for output signal.)
- 7.7. Strip motor by detected frequency : 16 Hz
- 7.8. Crank Time : 10 Sec
- 7.9. Protection Pause function time : 10 Sec (During 10 second after the Gen-set start normally, controller pause the faulty protection function except the emergency stop function and over speed function.)

8. Back Panel

8.1. Back Panel Outlook

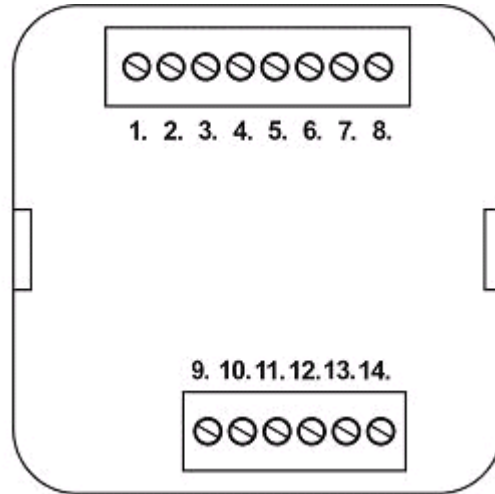

8.2. Pin Definition

Pin	Descriptions	Pin	Descriptions
1	Battery positive	9	Emergency Stop Switch Input
2	Battery Negative	10	High Water Temperature Switch Input
3	Motor Output	11	Low Oil Pressure Switch Input
4	Valve Output	12	Remote Start Input
5	Alarm Output	13	Frequency Input 1
6	Stop Output	14	Frequency Input 2
7	Pre-heat Output		
8	Charge Output		

8.3. Outlook

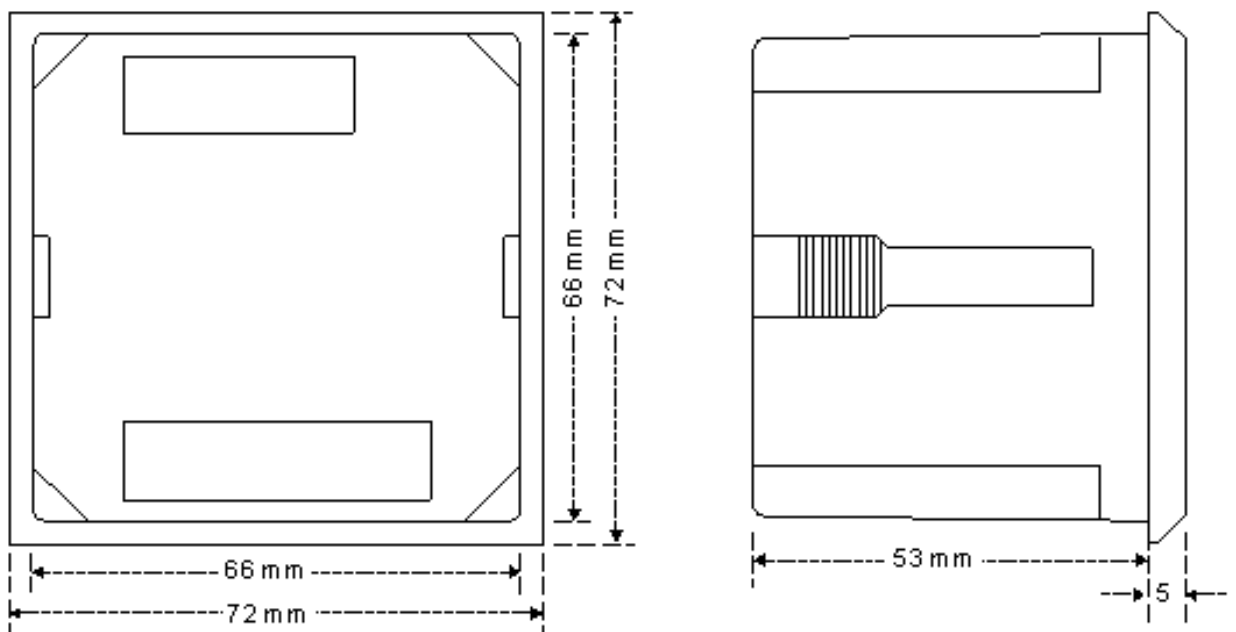

Back View

Side View

9. Wiring

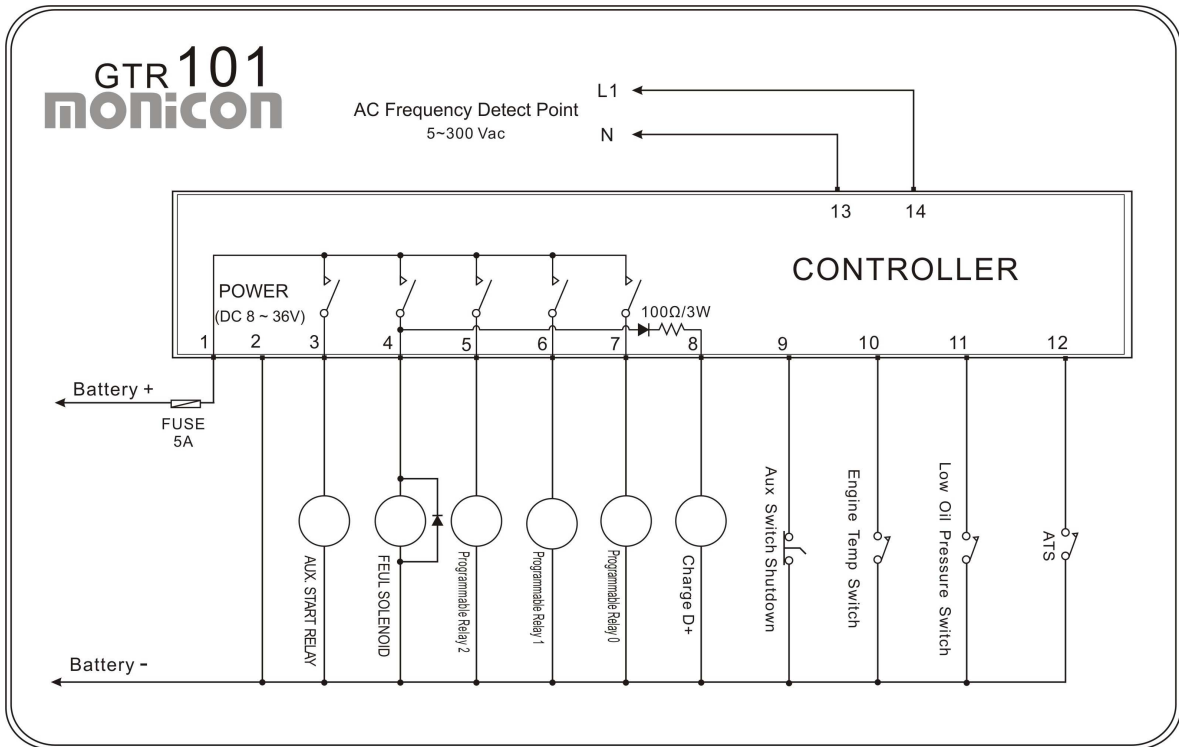

- ⊗ Note 1 : The pin 5~7 is programmable output relay, according user demand.
- ⊗ Note 2 : The setting value of output function just refer to "6、Parameter Setup" 6.12~6.14
- ⊗ Note 3 : Default Relay value are : Relay 0 : Preheat , Relay 1 : Stop , Relay 2 : Alarm